

axlent
italy

axlent
italy

**HERRAJES
VIDRIO TEMPLADO
Y ALUMINIO**

Zaragoza No. 2,
Col. Los Remedios,
Naucalpan de Juárez,
México, C.P. 53400

Tels.: 55 70 95 47 34 y 55 71 58 59 73

✉ atencion.italiamed@gmail.com

www.herrajesaxcent.com

2025
26

CONTENIDO

1 Carta de Garantía

3 Cerradores
Sistemas corredizos
Cerraduras • Chapas

14 Jaladeras • Arañas • Clips
Bisagras • Separadores

31 Soportes • Conectores • Complementos
Tapones • Bridas • Tapas • Postes • Clips • Aletas
Mini Postes • Grapa rectangular • Grapa redonda

47 Herrajes para acceso
Punto de giro • Cerradura de esquina • Herrajes
Bisagras hidráulicas • Sistema hidráulico

52 Línea para barra estabilizadora
Conectores

54 Línea Black
Sistemas corredizos • Cerraduras • Jaladeras • Clips • Bisagras • Soportes
Conectores • Mini Poste • Grapa rectangular • Cerradura de esquina
Herrajes • Tapa para bisagra hidráulica de piso

65 Línea Gold
Sistemas corredizos • Jaladeras
Clips • Bisagras

68 Línea Aluminio
Carretillas • Jaladeras • Topes • Chapas • Pasadores
Escuadras • Bisagras • Tirador • Brazos de proyección

79 Accesorios
Cintas doble cara
Guantes para vidrio

80 Contenido por clave

CARTA DE GARANTÍA

ITALIAMED, S.A. DE C.V., GARANTIZA este producto por el término de un año en todas sus partes, mano de obra y contra cualquier defecto de fabricación, apartir de la fecha en que el consumidor reciba el producto, considerando lo siguiente:

ESTA GARANTÍA NO ES EFECTIVA EN LOS SIGUIENTES CASOS:

- Cuando el producto ha sido utilizado en condiciones distintas a las normales.
- Cuando el producto no ha sido operado, manejado, instalado y limpiado correctamente.
- Cuando el producto ha sido alterado o reparado por externos a la empresa.

Se debe realizar la carta reclamo a **ITALIAMED, S.A. DE C.V.** o a su agente autorizado, dentro del periodo de garantía y a más tardar dentro de los primeros treinta (30) días calendario de ocurrido el incidente que motiva el reclamo.

LIMITACIONES DE LA GARANTÍA

ESTA GARANTÍA NO SERÁ VÁLIDA EN CASO DE NO SEGUIR LAS INDICACIONES SIGUIENTES:

MANTENIMIENTO DEL ACERO INOXIDABLE

Cuando aparecen trozos de corrosión después de algunos meses de instalado un producto, usualmente es resultado de un mal manejo, almacenaje o limpieza. Si aparecen manchas de corrosión, es posible restablecer el acabado con una simple limpieza. Los ingredientes de los productos de limpieza deben verificarse antes de emplearlos sobre el acero inoxidable, aún y cuando, estén catalogados como “limpiadores de acero inoxidable”. Debe evitarse el empleo de los limpiadores que contengan cloruros (base cloro) en su fórmula, o en su defecto, eliminarlos de la superficie mediante un vigoroso y concienzudo enjuagado para prevenir la corrosión. Los productos con ácido muriático o ácido clorhídrico nunca deben emplearse sobre el acero inoxidable, inclusive debe de evitarse usarlos cerca del mismo acero, ya que pueden provocar una rápida corrosión. Si la superficie del acero inoxidable ha sido contaminada con acero al carbón o hierro, la corrosión se desarrolla rápidamente y puede aparecer algunos días después de haber estado en exposición al ambiente exterior.

FACTORES QUE INFLUYEN EN LA CORROSIÓN:

1. Contaminación
 - i) Lluvia ácida.
 - ii) Dióxido de azufre y particulado.
2. Exposición a la sal costera.
3. Condiciones climáticas.
4. Mantenimiento.
5. Diseño.
 - i) Cavidades.
 - ii) Acabado.
6. Manejo y limpieza post-fabricación y colocación.

Para evitar el ataque de corrosión es conveniente tener en cuenta lo siguiente:

- Asegurar que las superficies se encuentren descontaminadas, eliminando toda traza de hierro, aluminio o restos abrasivos.
- No usar productos de limpieza a base de cloro.
- Utilizar solo agua y un paño húmedo.

Atentamente
ITALIAMED, S.A. DE C.V.

CERRADORES

Medidas en mm.

XH-073



Cerrador de puerta auto.

- Soporta: 120 kg.
- Acabado: Electrostático.
- Color: Plateado.

XH-072



Cerrador de puerta auto.

- Soporta: 80 kg.
- Acabado: Electrostático.
- Color: Plateado.

XH-071



Cerrador de puerta auto.

- Soporta: 65 kg.
- Acabado: Electrostático.
- Color: Plateado.

CERRADOR
INSTALADO



SOPORTE DE
CONEXIÓN

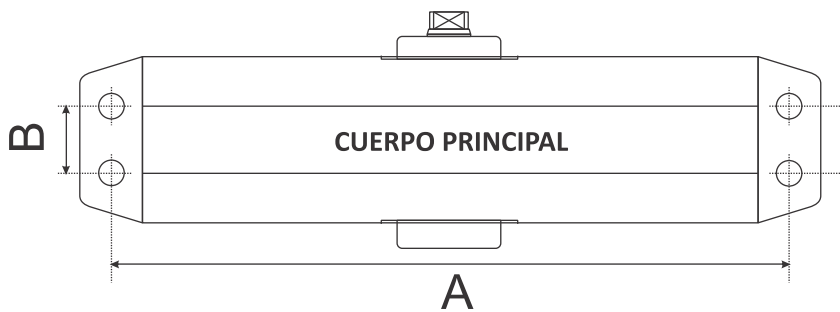
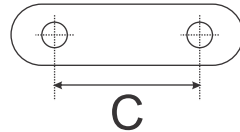

Modelo	A	B	C
XH-073	230	19	45
XH-072	188	20	40.5
XH-071	165	20	40.5

SISTEMAS CORREDIZOS

Medidas en mm.

KH01



Sistema corredizo sin tubo.

- Para: 8-10 mm.
- Material: Acero inox. 304.
- Acabado: Cromo.

KH01-Z



Sistema corredizo sin tubo.

- Para: 8-10 mm.
- Material: Zamac.
- Acabado: Cromo.

KH01Z-S

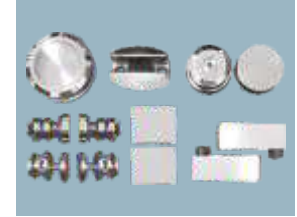

Sistema corredizo sin tubo.

- Para: 8-10 mm.
- Material: Zamac.
- Acabado: Satín.

KH01-S



Sistema corredizo sin tubo.

- Para: 8-10 mm.
- Material: Acero inox. 304
- Acabado: Satín.

KH02



Sistema corredizo sin tubo.

- Para: 10-12 mm.
- Material: Acero inox. 304
- Acabado: Satín.

KH03



Sistema corredizo con resaque sin tubo.

- Para: 8-12 mm.
- Material: Acero inox. 304
- Acabado: Satín.

B023



Jaladera redonda.

- Para: 6-10 mm.
- Material: Acero inox. 304
- Acabado: Satín.

N0115



Escuadra para sistema corredizo.

- Material: Acero inox. 304
- Acabado: Satín.

N0115-C



Escuadra para sistema corredizo.

- Material: Acero inox. 304
- Acabado: Cromo.

SISTEMAS CORREDIZOS

Medidas en mm.

N0208



Soporte a muro de sistema corredizo.

- **Material:** Acero inox. 304
- **Acabado:** Satín.

O15-S



Tubo (riel) cuadrado para sistema corredizo

- **Tamaño:** 10 x 30 mm
- **Largo:** 1.5 m
- **Calibre:** 16
- **Compatible:** KH01/KH01Z/KH01S
- **Material:** Acero inox. 304.
- **Acabado:** Satín.

O2-C • O2-S



Tubo (riel) cuadrado para sistema corredizo

- **Tamaño:** 10 x 30 mm
- **Largo:** 2 m
- **Calibre:** 16
- **Compatible:** KH01/KH01Z/KH01S
- **Material:** Acero inox. 304.
- **Acabado:** O2-C Cromo. O2-S Satín.

AL03



Riel cuadrado para sistema corredizo

- **Largo:** 3 m
- **Compatible:** KH03
- **Material:** Aluminio.
- **Acabado:** Satín.

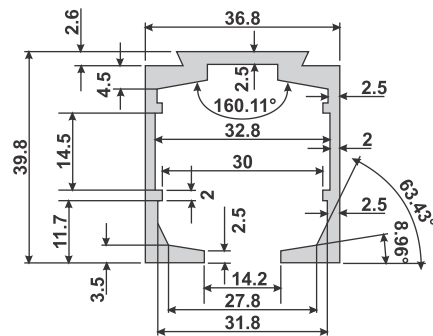

DEL CANTO DE LA HOJA AL CENTRO DEL BARRENO 100

SISTEMAS CORREDIZOS

Medidas en mm.

MODELOS KH01 / KH01-Z / KH01Z-S / KH01-S / KH01-B / KH01-G

Soporta: 70 kg Largo máximo: 1.8 m

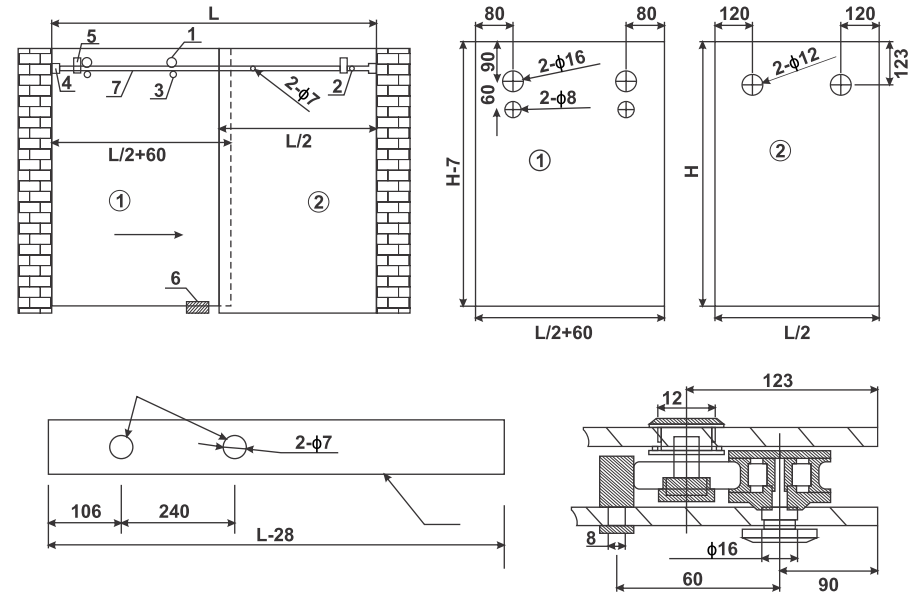

MODELOS KH02 / KH02-B

Soporta: 150 kg Largo máximo: 2.5 m

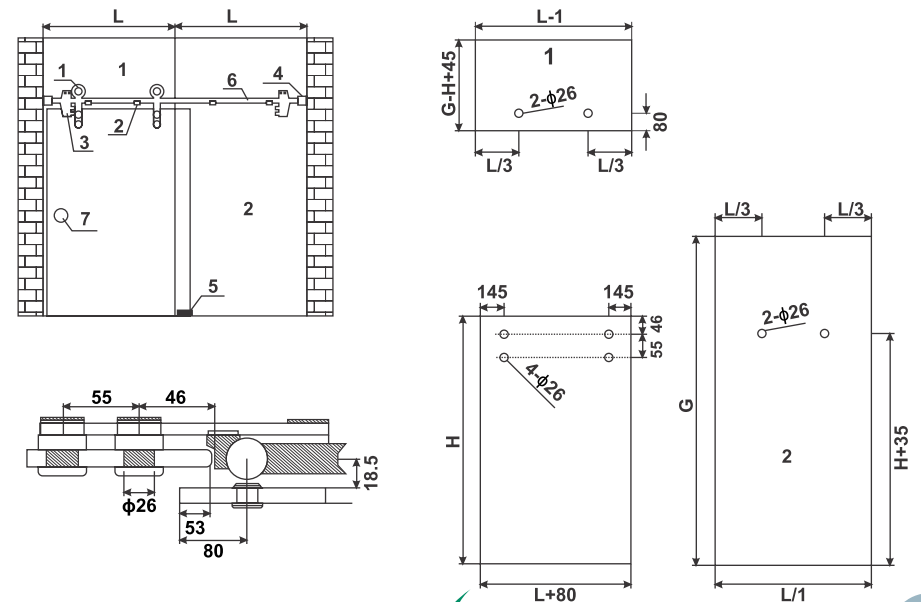

SISTEMAS CORREDIZOS

Medidas en mm.

MODELO KH03

Soporta: 90 kg Largo máximo: 2 m

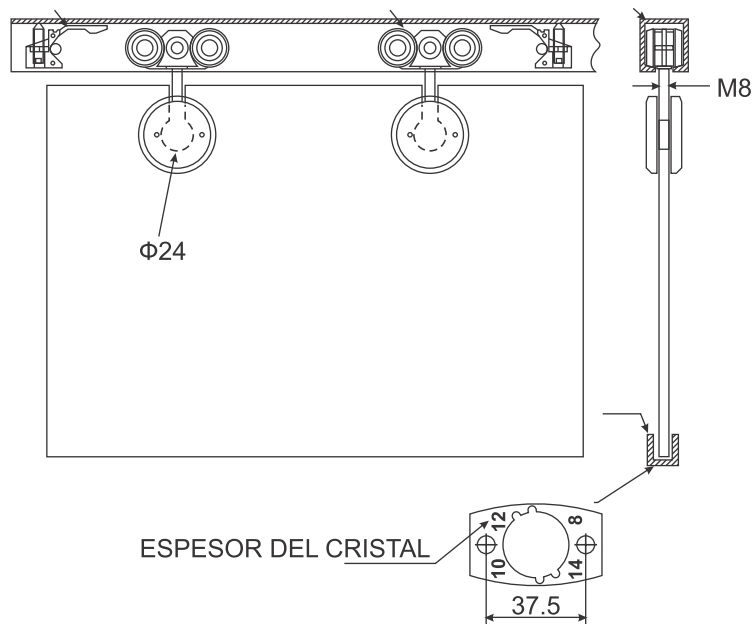

CERRADURAS

Medidas en mm.

XH-82801



Cerradura de puerta de cristal de mariposa.

- Para: 8-12 mm.
- Material: Acero inox. 304.
- Acabado: Satín.

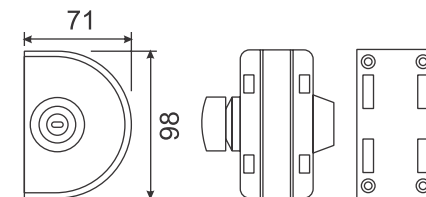

XH-82802



Cerradura de puerta de cristal plana.

- Para: 8-12 mm.
- Material: Acero inox. 304.
- Acabado: Satín.

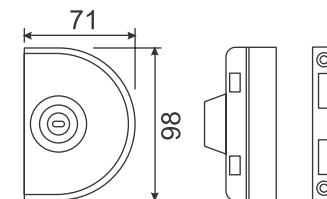

XH-82803



Cerradura de puerta de cristal doble de mariposa.

- Para: 8-12 mm.
- Material: Acero inox. 304.
- Acabado: Satín.

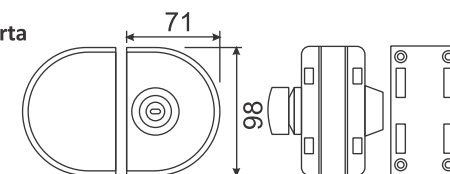

XH-82804



Cerradura de puerta de cristal doble plana.

- Para: 8-12 mm.
- Material: Acero inox. 304.
- Acabado: Satín.

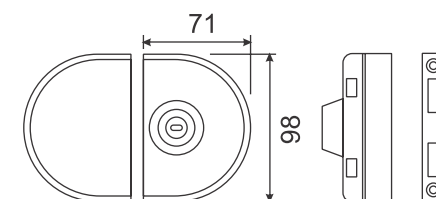

XH-82805



Cerradura de puerta de cristal de doble llave.

- Para: 8-12 mm.
- Material: Acero inox. 304.
- Acabado: Satín.

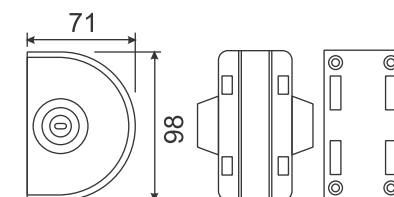

CERRADURAS

Medidas en mm.

XH-82806



Cerradura de puerta de cristal doble de doble llave.

- Para: 8-12 mm.
- Material: Acero inox. 304.
- Acabado: Satín.

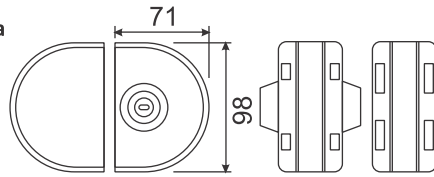

MODELOS XH-82801 AL XH-82806

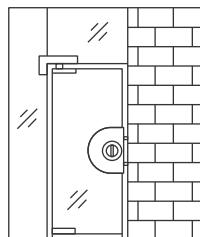
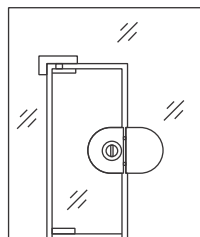
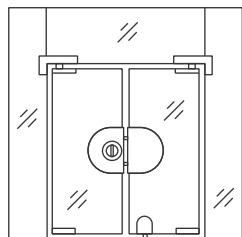
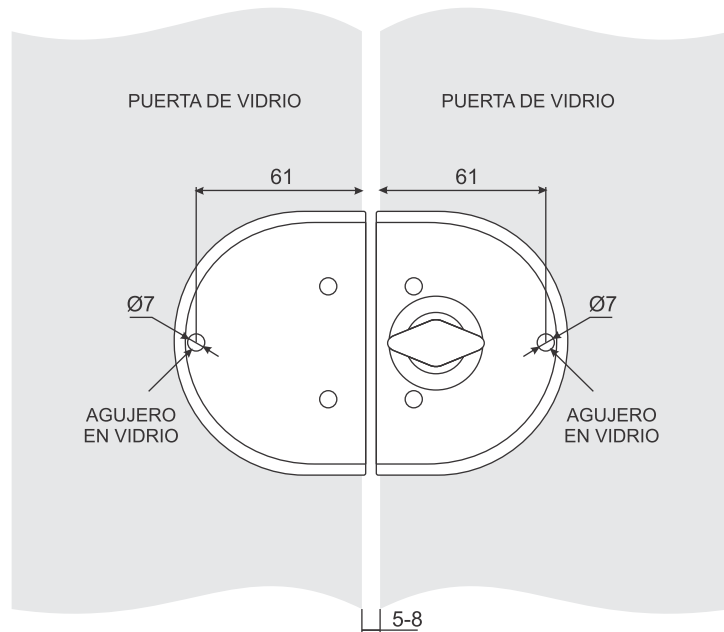

CERRADURAS

Medidas en mm.

XH-83101

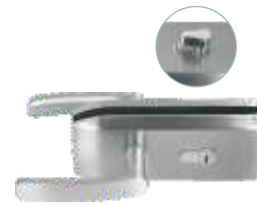

Cerradura con mango.

- Para: 8-12 mm.
- Material: Acero inox. 304.
- Acabado: Satín.

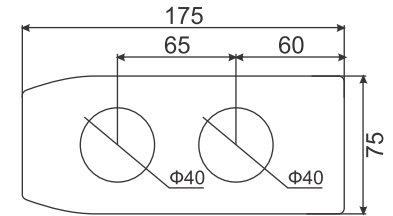

XH-83102P



Contra para cerradura con mango.

- Para: 8-12 mm.
- Material: Acero inox. 304.
- Acabado: Satín.

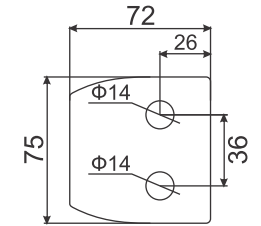

XH-83301



Cerradura de puerta corrediza.

- Para: 8-15 mm.
- Material: Acero inox. 304.
- Acabado: Satín.

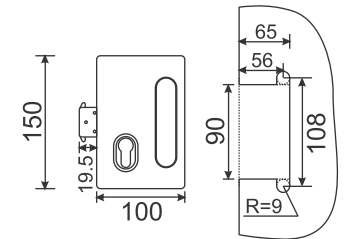

XH-83302



Cerradura de puerta corrediza doble.

- Para: 8-15 mm.
- Material: Acero inox. 304.
- Acabado: Satín.

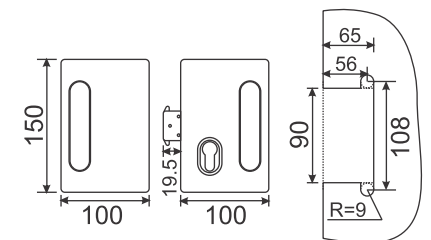

XH-84201



Cerradura de armario de cristal.

- Para: 6-12 mm.
- Material: Acero inox. 304.
- Acabado: Satín.

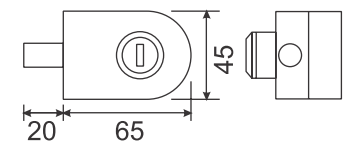

CERRADURAS

Medidas en mm.

XH-84202



Cerradura de armario de cristal doble.

- Para: 6-12 mm.
- Material: Acero inox. 304.
- Acabado: Satín.

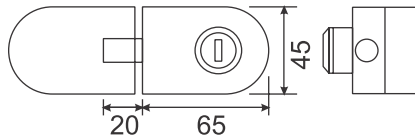

XH-84201-K



Cerradura de armario para cristal mariposa.

- Para: 6-12 mm.
- Material: Acero inox. 304.
- Acabado: Satín.

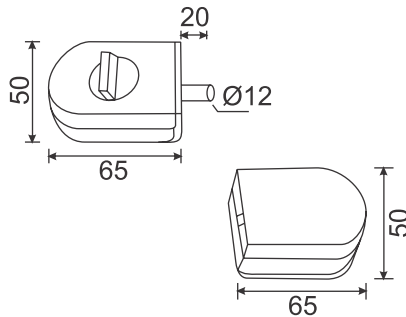

XH-84202-K



Cerradura de armario doble para cristal mariposa.

- Para: 6-12 mm.
- Material: Acero inox. 304.
- Acabado: Satín.

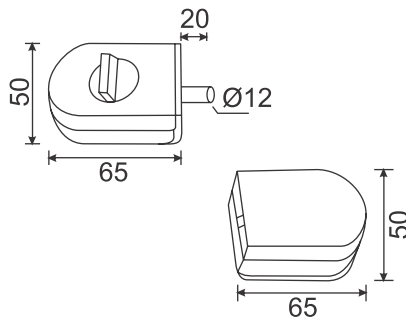

XH-84801



Cerradura de gancho para puerta.

- Para: 8-12 mm.
- Material: Acero inox. 304.
- Acabado: Satín.

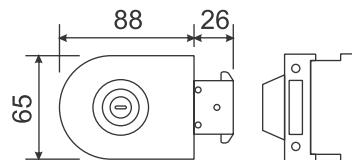

CERRADURAS

Medidas en mm.

XH-84802P



Contracara para cerradura de gancho.

- Para: 8-12 mm.
- Material: Acero inox. 304.
- Acabado: Satín.

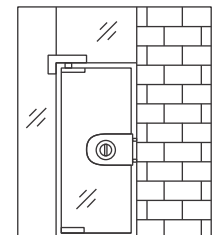
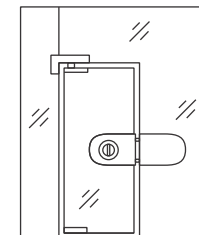
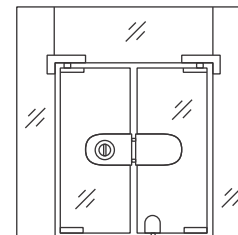
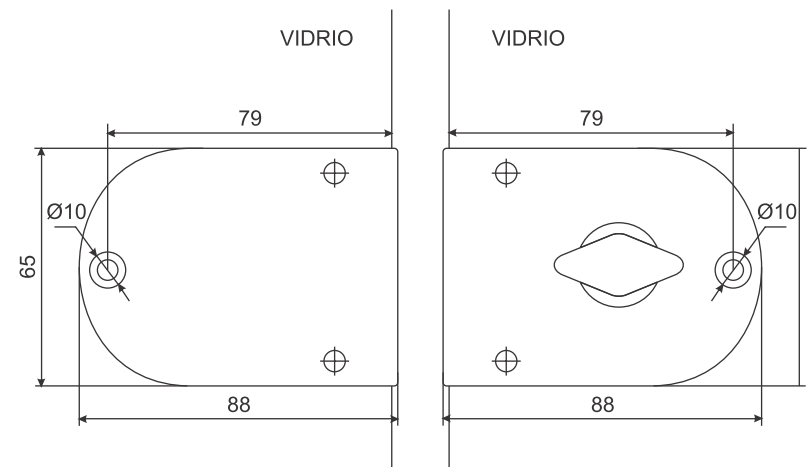
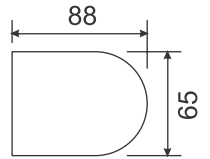

CHAPAS

Medidas en mm.

J101



Chapa cuadrada para vitrina.

- Para: 6-10 mm.
- Material: Zamac.
- Acabado: Satín.

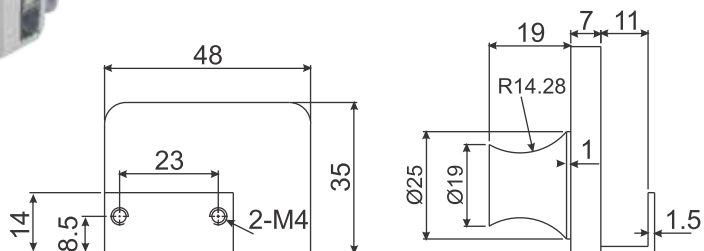

J102



Chapa ovalada para vitrina.

- Para: 6-10 mm.
- Material: Zamac.
- Acabado: Satín.

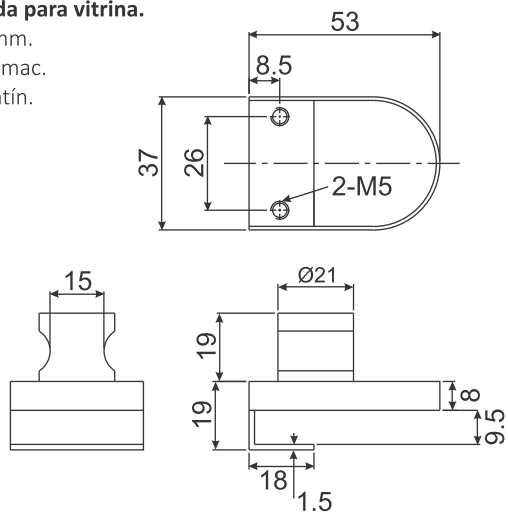

JALADERAS

Medidas en mm.

K-246-C • K-246-S



Jaladera 30*30.

- Material: Aluminio.
- Acabado:
K-246-C Cromo.
K-246-S Satín.

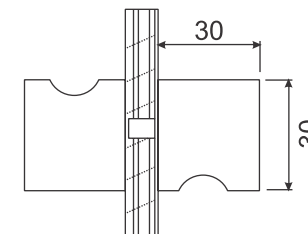

K-247-C • K-247-S



Jaladera 30*30.

- Material: Aluminio.
- Acabado:
K-247-C Cromo.
K-247-S Satín.

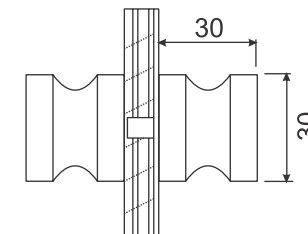

K-264-C



Jaladera 30*30.

- Material: Aluminio.
- Acabado: Cromo.

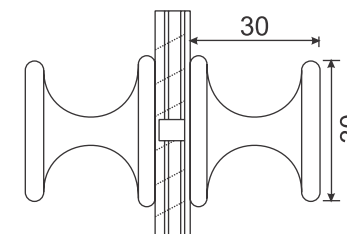

25*300-C



Jaladera de 30.

- Para: 8-12 mm.
- Material:
Acero inox. 304.
- Acabado: Cromo.

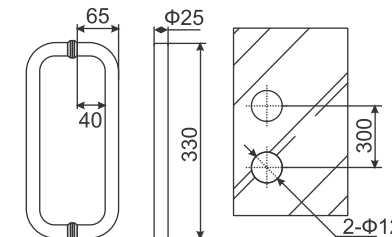

25*300-SN



Jaladera de 30.

- Para: 8-12 mm.
- Material:
Acero inox. 304.
- Acabado: Satín.

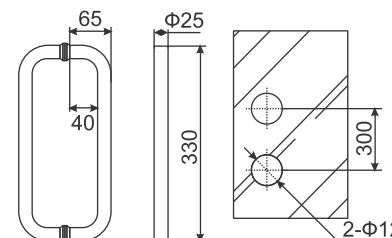

JALADERAS

Medidas en mm.

19*150-C



- Jaladera de 15.**
- Para: 8-12 mm.
 - Material: Acero inox. 304.
 - Acabado: Cromo.

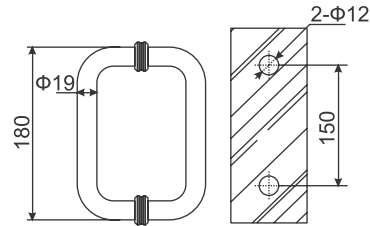

19*150-SN



- Jaladera de 15.**
- Para: 8-12 mm.
 - Material: Acero inox. 304.
 - Acabado: Satín.

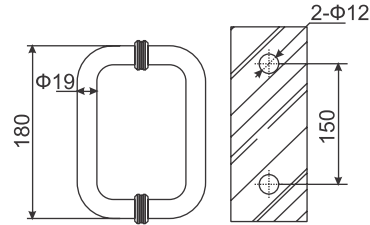

SH-250-50 • SH-250-90 • SH-250-120 • SH-250-150



- Jaladera tipo H de 1-1/4.**
- Material: Acero inox. 304.
 - Acabado: Satín.
 - SH-250-50 (50 cm) centros a 30 cm.
 - SH-250-90 (90 cm) centros a 50 cm.
 - SH-250-120 (120 cm) centros a 80 cm.
 - SH-250-150 (150 cm) centros a 100 cm.



SH-250-SQ-120 • SH-250-SQ-150



- Jaladera tipo H cuadrada.**
- Material: Acero inox. 304.
 - Acabado: Satín.
 - SH-250-SQ-120 (120 cm) centros a 100 cm.
 - SH-250-SQ-150 (150 cm) centros a 120 cm.

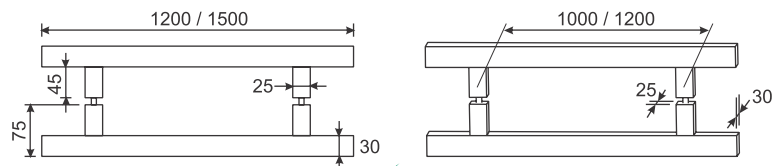

JALADERAS

Medidas en mm.

SH-530-20*45



- Jaladera toallero 20*45**
- Material: Acero inox. 304.
 - Acabado: Satín.

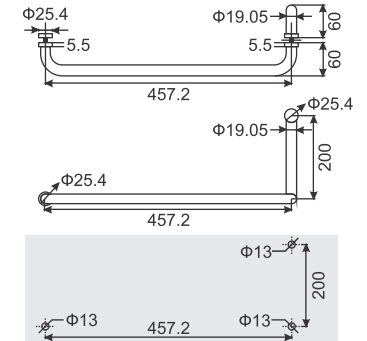

SH-270



- Barra toallero**
- Material: Acero inox. 304.
 - Acabado: Satín.

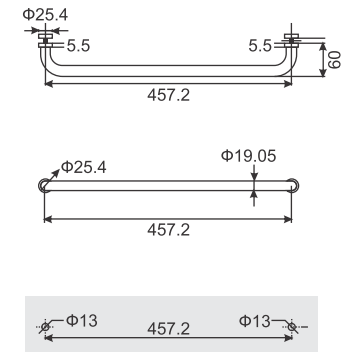

SH260



- Barra de seguridad.**
- De: 50 cm.
 - Tubo: 1 1/4".
 - Material: Acero inox. 304.
 - Acabado: Satín.

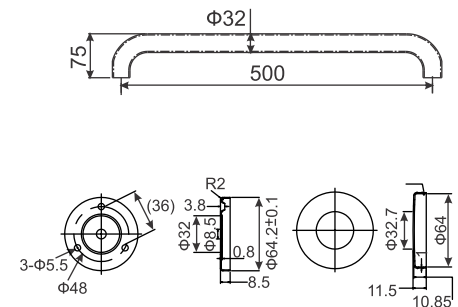

JALADERAS

Medidas en mm.

SH-250-K-120 • SH-250-K-150



Jaladera H con chapa.

- Material: Acero inox. 304.
- Acabado: Satín.
- Llave/mariposa.
- SH-250-K-120 (120 cm).
- SH-250-K-150 (150 cm).

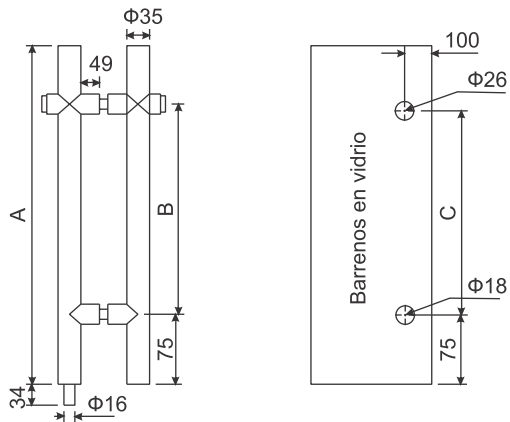

A	B	C
1200	925	925
1500	1125	1125

ARAÑAS

Medidas en mm.

K120



Araña Baby 4 patas.

- Material: Acero inox. 316.
- Acabado: Satín.

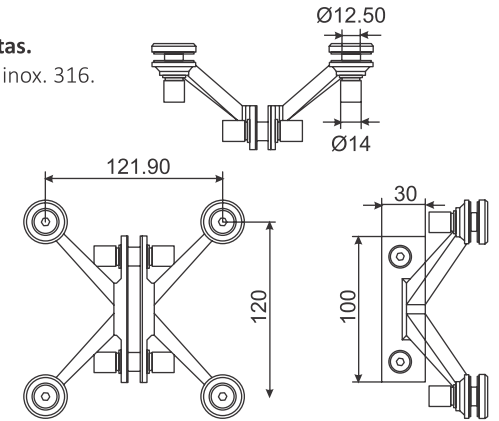

T120



Araña Baby 2 patas.

- Material: Acero inox. 316.
- Acabado: Satín.

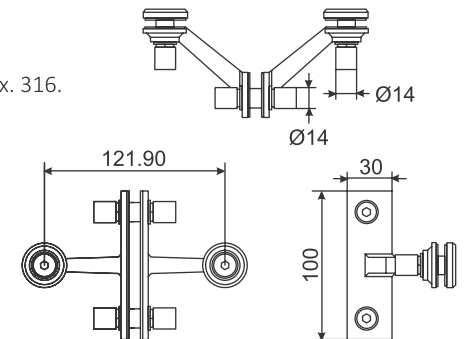

K200



Araña 4 patas con portacostilla.

- Material: Acero inox. 316.
- Acabado: Satín.

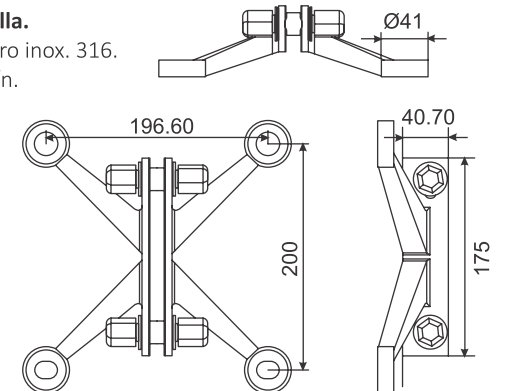

ARAÑAS

Medidas en mm.

T200

Araña 2 patas con portacostilla.

- Material: Acero inox. 316.
- Acabado: Satín.

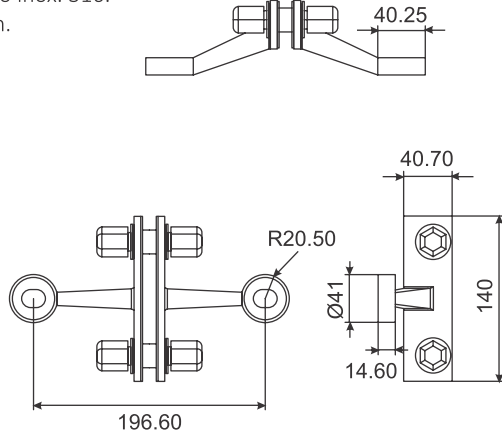

CN200

Rótula para araña.

- Material: Acero inox. 316.
- Acabado: Satín.

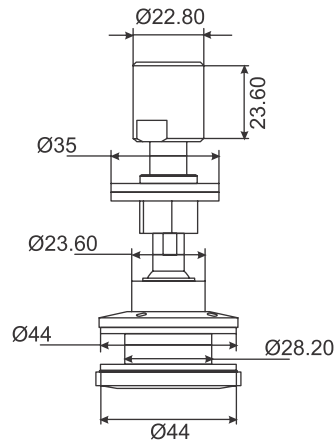
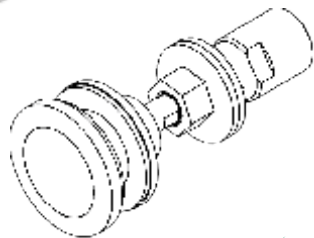

CLIPS

Medidas en mm.

K-121-12-C • K-121-12-S



Clip para cristal.

- Para: 8-12 mm.
- Soporta: 15 kg.
- Material: Zamac.
- Acabado: K-121-12-C Cromo. K-121-12-S Satín.

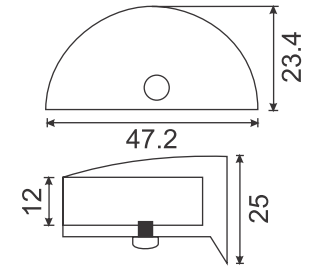

K-128-12-C • K-128-12-S



Clip para cristal.

- Para: 8-12 mm.
- Soporta: 15 kg.
- Material: Zamac.
- Acabado: K-128-12-C Cromo. K-128-12-S Satín.

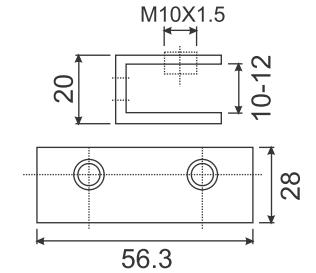

K-239-L



Clip para cristal.

- Para: 8-12 mm.
- Soporta: 15 kg.
- Material: Zamac.
- Acabado: Satín.

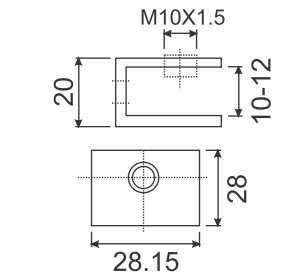

K-169-C • K-169-S



Clip.

- Para: 5-15 mm.
- Soporta: 25 kg.
- Material: Zamac.
- Acabado: K-169-C Cromo. K-169-S Satín.

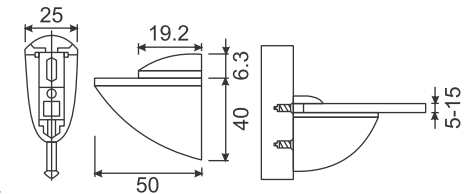

K-170-C • K-170-S



Clip.

- Para: 5-25 mm.
- Soporta: 35 kg.
- Material: Zamac.
- Acabado: K-170-C Cromo. K-170-S Satín.

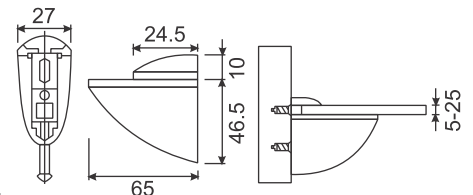

CLIPS

Medidas en mm.

K-170-1-C • K-170-1-S



Clip.

- Para: 5-30 mm.
- Soporta: 55 kg.
- Material: Zamac.
- Acabado:
K-170-1-C Cromo.
K-170-1-S Satín.

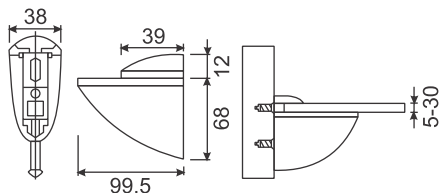

K-826



Clip.

- Para: 5-15 mm.
- Soporta: 20 kg.
- Material: Zamac.
- Acabado:
Níquel perlado.

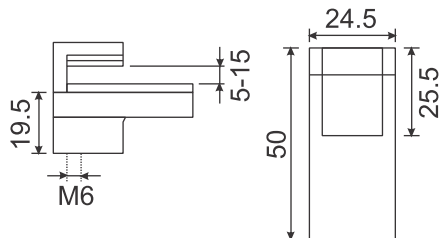

K-827



Clip.

- Para: 5-20 mm.
- Soporta: 20 kg.
- Material: Zamac.
- Acabado:
Níquel perlado.

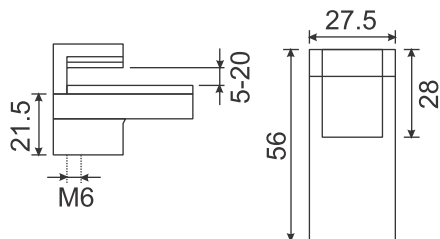

K-163-1



Clip.

- Para: 3-40 mm.
- Soporta: 55 kg.
- Material: Zamac.
- Acabado:
Níquel perlado.

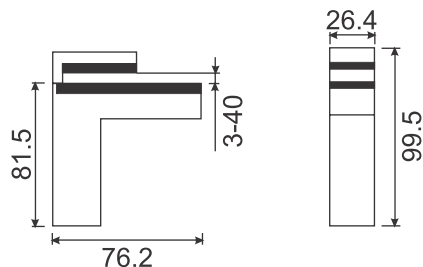

K-165



Clip.

- Para: 3-15 mm.
- Soporta: 20 kg.
- Material: Zamac.
- Acabado: Satín.

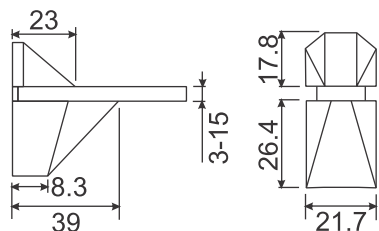

CLIPS

Medidas en mm.

K-166



Clip.

- Para: 3-25 mm.
- Soporta: 35 kg.
- Material: Zamac.
- Acabado: Satín.

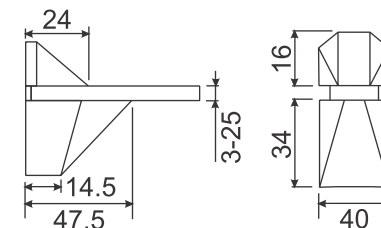

K-822



Clip.

- Para: 8 mm.
- Soporta: 15 kg.
- Material: Acero inox. 304.
- Acabado: Satín.
- Venta por par.

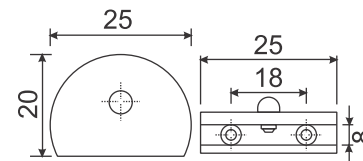

K-823



Clip.

- Para: 10 mm.
- Soporta: 15 kg.
- Material: Acero inox. 304.
- Acabado: Satín.
- Venta por par.

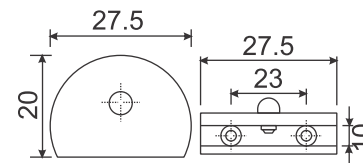

K-824



Clip.

- Para: 12 mm.
- Soporta: 15 kg.
- Material: Acero inox. 304.
- Acabado: Satín.
- Venta por par.

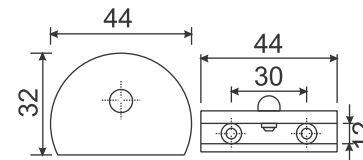

K-510-C • K-510



Clip 135°.

- Para: 8-10 mm.
- Soporta: 50 kg.
- Material: Acero inox. 304.
- Acabado:
K-510-C Cromo.
K-510 Satín.

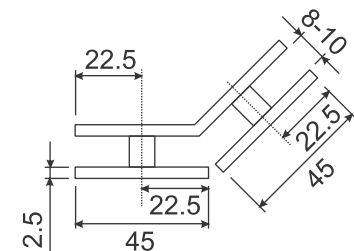

CLIPS

Medidas en mm.

K-512-C • K-512



Clip 180°.

- Para: 8-10 mm.
- Soporta: 50 kg.
- Material: Acero inox. 304.
- Acabado:
K-512-C Cromo.
K-512 Satín.

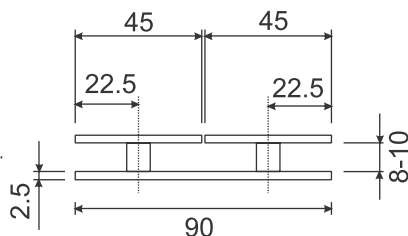

K-513



Clip.

- Para: 8-10 mm.
- Soporta: 50 kg.
- Material: Acero inox. 304.
- Acabado: Satín.

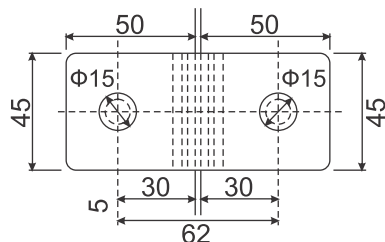

K-518-C • K-518

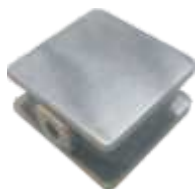

Clip.

- Para: 8-10 mm.
- Soporta: 50 kg.
- Material: Acero inox. 304.
- Acabado:
K-518-C Cromo.
K-518 Satín.

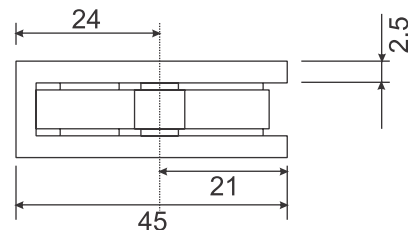

K-507-C • K-507



Clip 90°.

- Para: 8-10 mm.
- Soporta: 50 kg.
- Material: Acero inox. 304.
- Acabado:
K-507-C Cromo.
K-507 Satín.

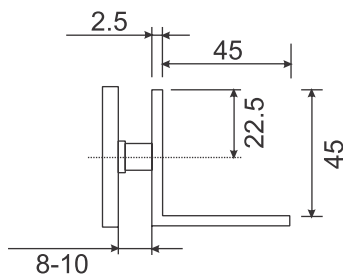

K-508-C • K-508



Clip 90°.

- Para: 8-10 mm.
- Soporta: 50 kg.
- Material: Acero inox. 304.
- Acabado:
K-508-C Cromo.
K-508 Satín.

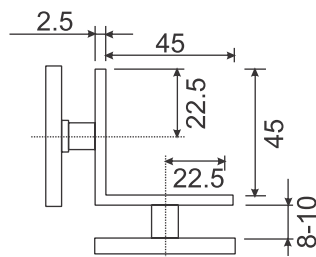

BISAGRAS

Medidas en mm.

K-858-C • K-858-S



Bisagra.

- Para: 6 mm.
- Soporta: 20 kg.
- Material: Zamac.
- Acabado:
K-858-C Cromo.
K-858-S Satín.

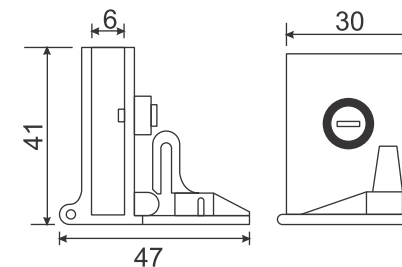

K-861-C • K-861-S



Bisagra.

- Para: 6-10 mm.
- Soporta: 35 kg.
- Material: Zamac.
- Acabado:
K-861-C Cromo.
K-861-S Satín.

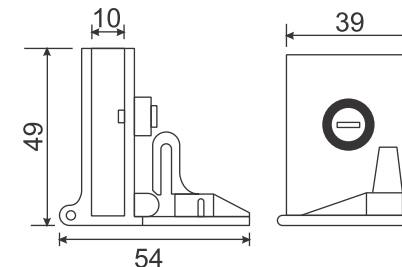

K-862-C • K-862-S



Bisagra.

- Para: 6-10 mm.
- Soporta: 50 kg.
- Material: Zamac.
- Acabado:
K-862-C Cromo.
K-862-S Satín.

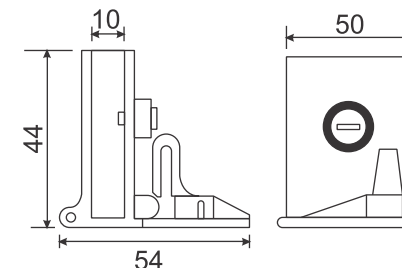

K-844



Bisagra plana.

- Para: 6-10 mm.
- Soporta: 25 kg.
- Material: Zamac.
- Acabado: Satín.

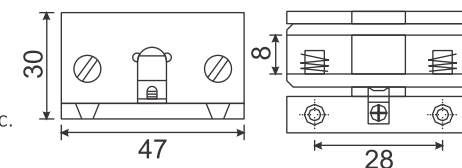

K-846



Bisagra curva.

- Para: 6-10 mm.
- Soporta: 25 kg.
- Material: Zamac.
- Acabado: Satín.

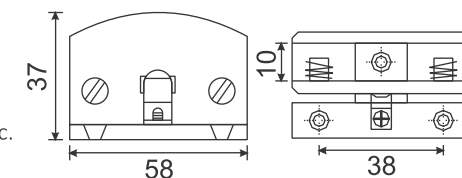

BISAGRAS

Medidas en mm.

K-174-10



Bisagra.

- Para: 6-10 mm.
- Soporta: 35 kg.
- Material: Acero inox. 304.
- Acabado: Satín.

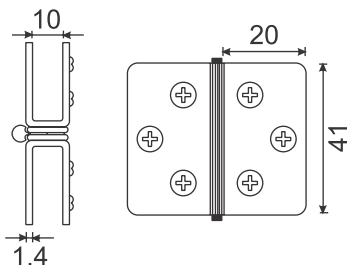

K-946



Bisagra.

- Para: 6-10 mm.
- Soporta: 30 kg.
- Material: Acero inox. 304.
- Acabado: Satín.
- Venta por set.

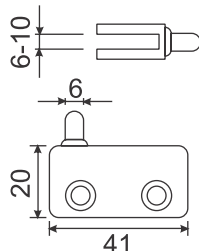

K-947



Bisagra.

- Para: 10-12 mm.
- Soporta: 30 kg.
- Material: Acero inox.
- Acabado: Satín.
- Venta por set.

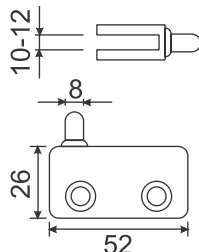

K-803



Bisagra.

- Para: 8 mm.
- Soporta: 35 kg.
- Material: Zamac.
- Acabado: Satín.

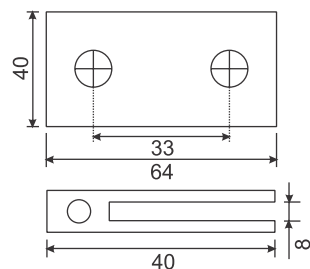

ZL6214-C • ZL6214-SN



Bisagra muro a cristal centrada.

- Para: 8-12 mm.
- Soporta: 25 kg.
- Material: Zamac.
- Acabado: ZL6214-C Cromo. ZL6214-SN Satín.

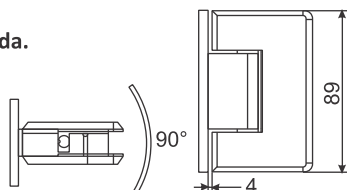

BISAGRAS

Medidas en mm.

ZL6215-C • ZL6215-SN



Bisagra muro a cristal desfasada.

- Para: 8-12 mm.
- Soporta: 25 kg.
- Material: Zamac.
- Acabado: ZL6215-C Cromo. ZL6215-SN Satín.

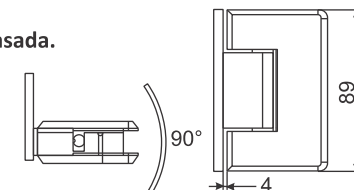

MODELOS ZL6214 / ZL6215

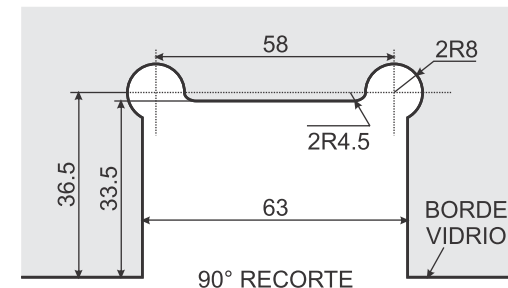

Z6216-C • Z6216-SN



Bisagra cristal a cristal 135°.

- Para: 8-12 mm.
- Soporta: 25 kg.
- Material: Zamac.
- Acabado: Z6216-C Cromo. Z6216-SN Satín.

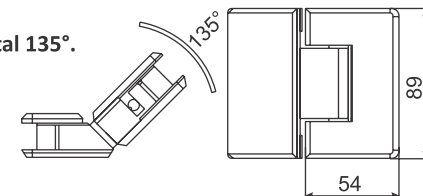

Z6217-C • Z6217-SN



Bisagra cristal a cristal 180°.

- Para: 8-12 mm.
- Soporta: 25 kg.
- Material: Zamac.
- Acabado: Z6217-C Cromo. Z6217-SN Satín.

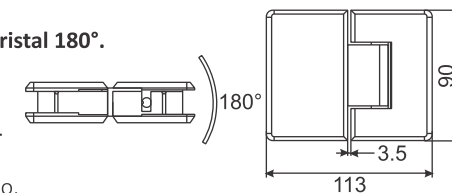

Z6218-C • Z6218-SN



Bisagra cristal a cristal 90°.

- Para: 8-12 mm.
- Soporta: 25 kg.
- Material: Zamac.
- Acabado: Z6218-C Cromo. Z6218-SN Satín.

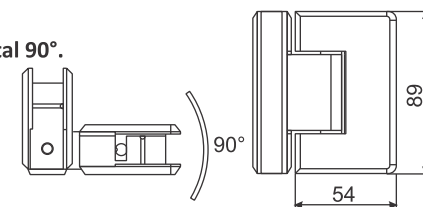

BISAGRAS

Medidas en mm.

MODELOS Z6216 / Z6217 / Z6218

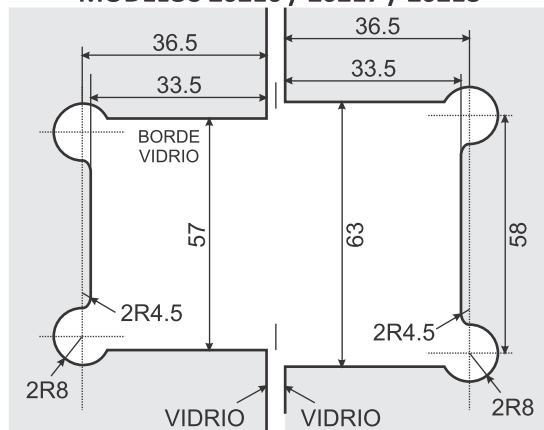

SH310-C • SH310-S



Bisagra muro a cristal desfasada.

- Para: 8-12 mm.
- Soporta: 25 kg.
- Material: Acero inox. 304.
- Acabado:
SH310-C Cromo.
SH310-S Satín.

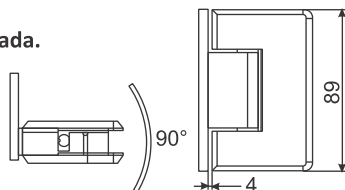

SH320-C • SH320-S



Bisagra muro a cristal centrada.

- Para: 8-12 mm.
- Soporta: 25 kg.
- Material: Acero inox. 304.
- Acabado:
SH320-C Cromo.
SH320-S Satín.

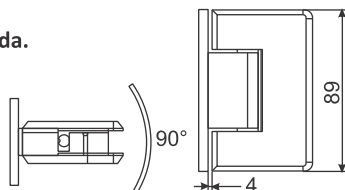

MODELOS SH310 / SH320

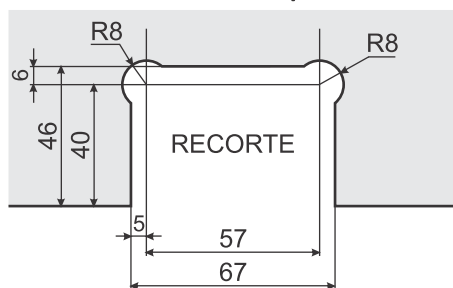

BISAGRAS

Medidas en mm.

SH330-C • SH330-S



Bisagra cristal a cristal 180°.

- Para: 8-12 mm.
- Soporta: 25 kg.
- Material:
Acero inox. 304.
- Acabado:
SH330-C Cromo.
SH330-S Satín.

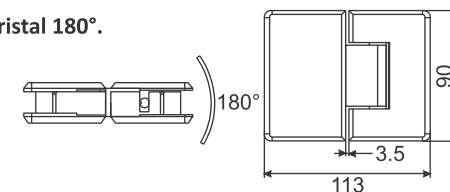

SH340-C • SH340-S



Bisagra cristal a cristal 135°.

- Para: 8-12 mm.
- Soporta: 25 kg.
- Material:
Acero inox. 304.
- Acabado:
SH340-C Cromo.
SH340-S Satín.

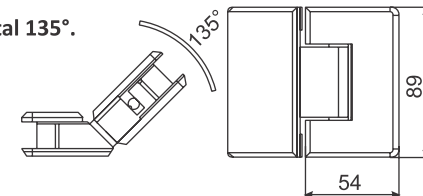

SH350-C • SH350-S



Bisagra cristal a cristal 90°.

- Para: 8-12 mm.
- Soporta: 25 kg.
- Material:
Acero inox. 304.
- Acabado:
SH350-C Cromo.
SH350-S Satín.

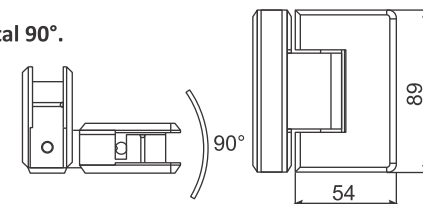

MODELOS SH330 / SH340 / SH350

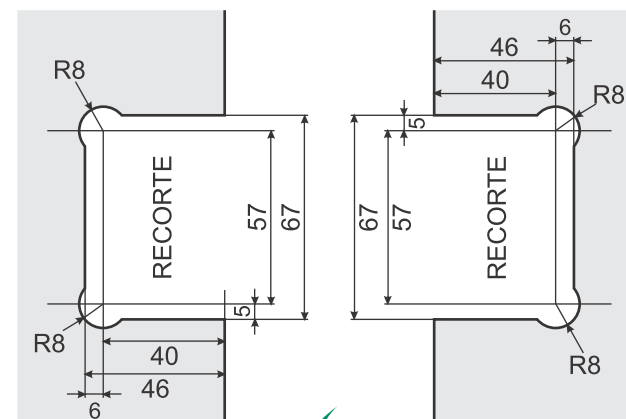

BISAGRAS

Medidas en mm.

SH300-C • SH300-S



Bisagra pivotante.

- Para: 8-12 mm.
- Soporta: 25 kg.
- Material: Acero inox. 304.
- Acabado: SH300-C Cromo. SH300-S Satín.

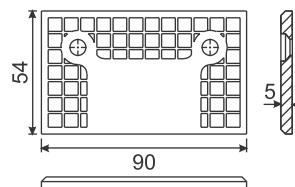

MODELOS SH300

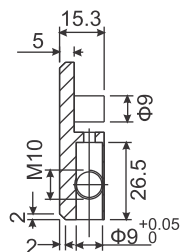
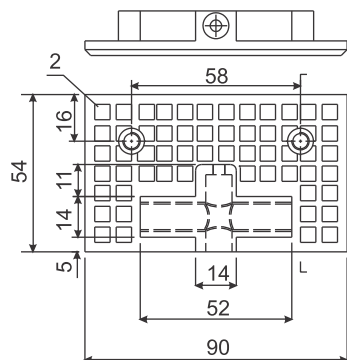
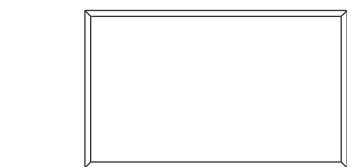
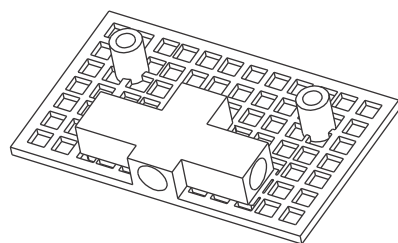
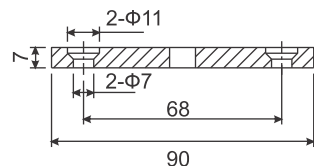
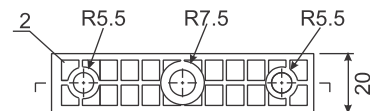
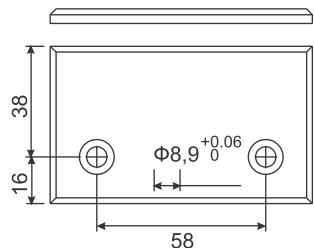
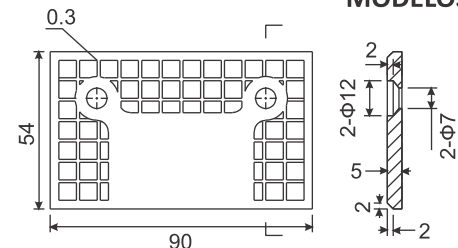

SEPARADORES

Medidas en mm.

K-258-1



Separador redondo hueco.

Varias medidas.

- Soporta: 30 kg.
- Material: Acero inox. 304.
- Acabado: Satín.

- k-258-1-19*20 19*20
- k-258-1-19*25 19*25
- k-258-1-19*30 19*30
- k-258-1-25*20 25*20
- k-258-1-25*25 25*25
- k-258-1-25*30 25*30
- k-258-1-25*40 25*40
- k-258-1-30*40 30*40
- k-258-1-30*50 30*50
- k-258-1-30*60 30*60
- k-258-1-30*70 30*70
- k-258-1-40*40 40*40
- k-258-1-40*50 40*50
- k-258-1-40*60 40*60
- k-258-1-40*70 40*70

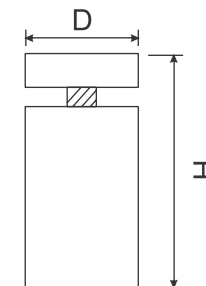

D \ H	20	25	30	40	50	60	70	80	100
12	20	25	30	40	50	60	70	80	100
16	20	25	30	40	50	60	70	80	100
19	20	25	30	40	50	60	70	80	100
25	20	25	30	40	50	60	70	80	100
30	20	25	30	40	50	60	70	80	100
40	20	25	30	40	50	60	70	80	100

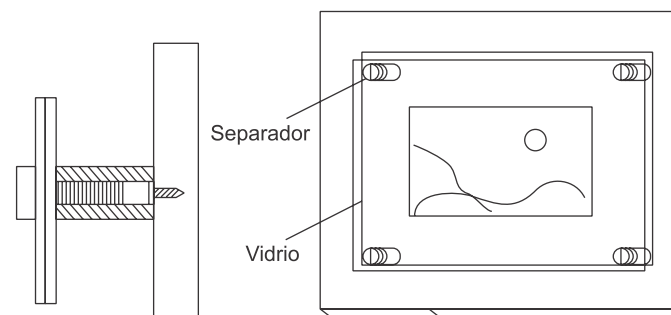

SOPORTES

Medidas en mm.

C-005



Soporte de fijación doble tapa.

- Para: 8-12 mm.
- Soporta: 30 kg.
- Material: Acero inox. 304.
- Acabado: Satín.

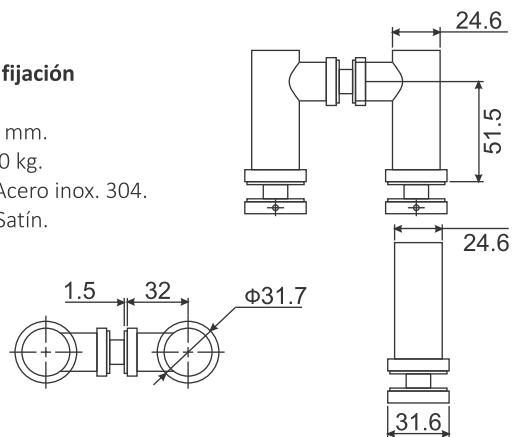

C-003



Soporte de fijación muro a cristal.

- Para: 8-12 mm.
- Soporta: 30 kg.
- Material: Acero inox. 304.
- Acabado: Satín.

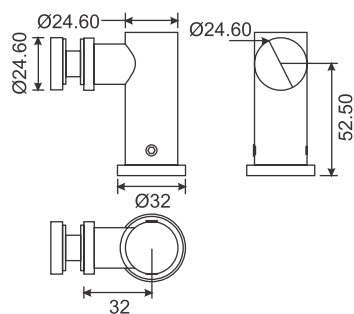

C-004



Soporte de fijación muro a cristal con taquete.

- Para: 8-12 mm.
- Soporta: 30 kg.
- Material: Acero inox. 304.
- Acabado: Satín.

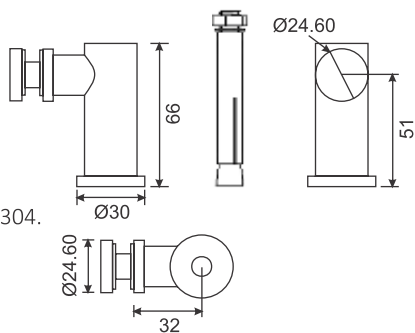

C-001



Soporte de fijación cristal a cristal.

- Para: 8-12 mm.
- Soporta: 30 kg.
- Material: Acero inox. 304.
- Acabado: Satín.

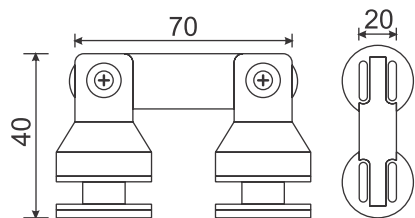

SOPORTES

Medidas en mm.

K-957-25



Soporte para tubo.

- Para: 1 pulgada.
- Soporta: 20 kg.
- Material: Acero inox. 304.
- Acabado: Satín.
- Venta por par.

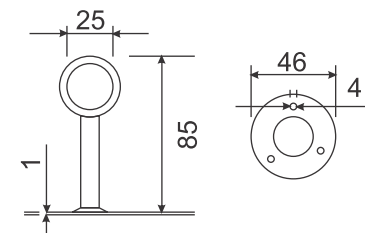

K-957-32



Soporte para tubo.

- Para: 1.5 pulgadas.
- Soporta: 20 kg.
- Material: Acero inox. 304.
- Acabado: Satín.
- Venta por par.

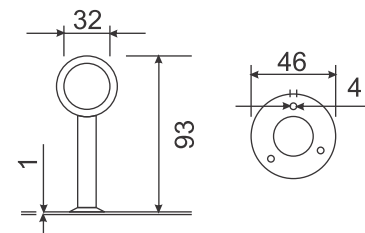

K-961-25



Soporte para tubo.

- Para: 1 pulgada.
- Soporta: 20 kg.
- Material: Acero inox. 304.
- Acabado: Satín.
- Venta por par.

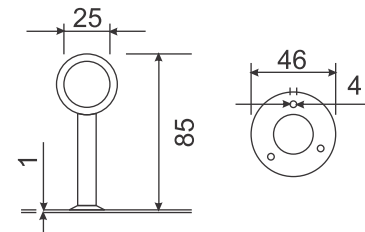

K-961-32



Soporte para tubo.

- Para: 1.5 pulgadas.
- Soporta: 20 kg.
- Material: Acero inox. 304.
- Acabado: Satín.
- Venta por par.

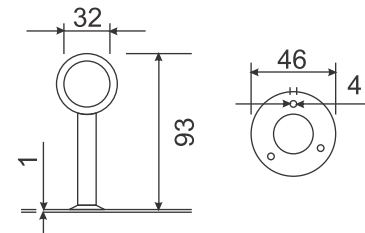

CONECTORES

Medidas en mm.

M063



Conector intermedio poste.

- Tubo: 1/2".
- Material: Acero inox. 304.
- Acabado: Satín.

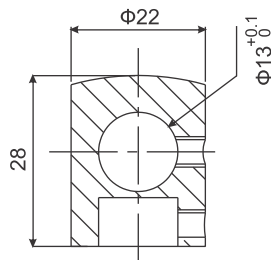

M063-L



Conector izquierdo poste.

- Tubo: 1/2".
- Material: Acero inox. 304.
- Acabado: Satín.

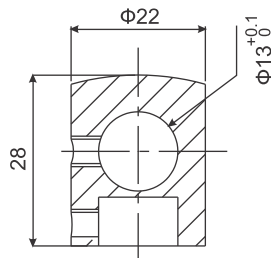

M063-R



Conector derecho poste.

- Tubo: 1/2".
- Material: Acero inox. 304.
- Acabado: Satín.

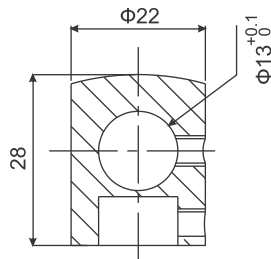

MODELOS M063 / M063-L / M063-R

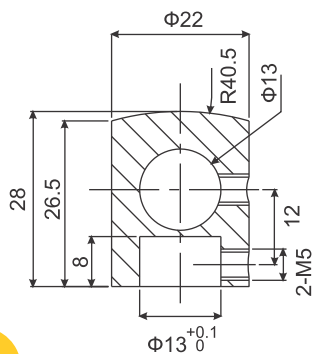

axlent
italy

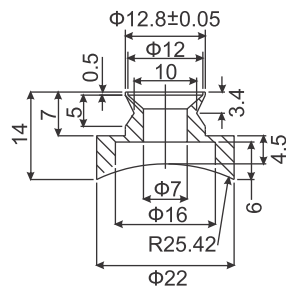

CONECTORES

Medidas en mm.

PH800-1-SN



Conector muro a tubo.

- Soporta: 30 kg.
- Material: Acero inox. 304.
- Acabado: Satín.

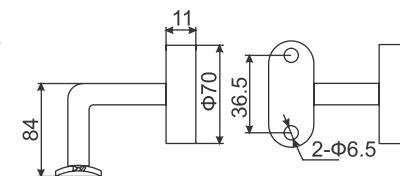

PH804-1-SN



Conector muro a tubo.

- Soporta: 30 kg.
- Material: Acero inox. 304.
- Acabado: Satín.

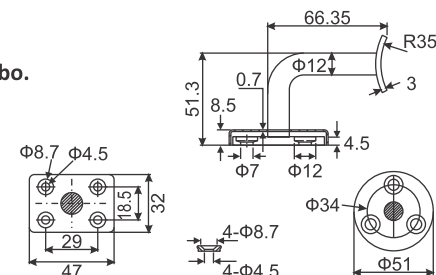

PH800-SN



Conector vidrio a tubo.

- Para: 8-12 mm.
- Soporta: 30 kg.
- Material: Acero inox. 304.
- Acabado: Satín.

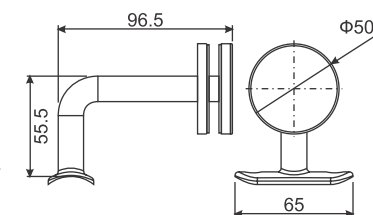

PH804-SN



Conector vidrio a tubo.

- Para: 8-12 mm.
- Soporta: 30 kg.
- Material: Acero inox. 304.
- Acabado: Satín.

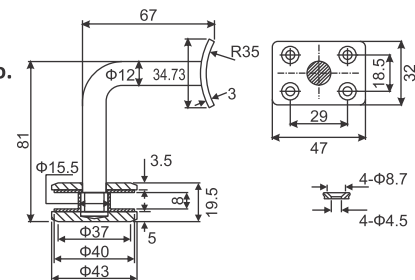

C011



Conector vidrio a vidrio.

- Material: Acero inox. 304.
- Acabado: Satín.

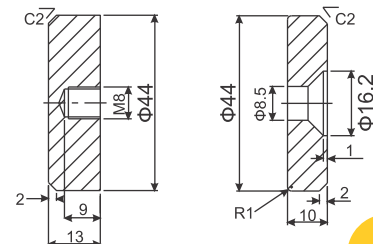

axlent
italy

CONECTORES

Medidas en mm.

ALC011



Botón estabilizador vidrio a vidrio.

- *Material:* Aluminio.
- *Acabado:* Satín.

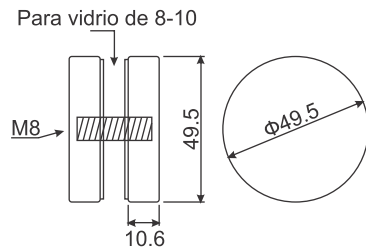

M112



Conector tubo a tubo 180°.

- *Para:* Tubo de 2".
- *Material:* Acero inox. 304.
- *Acabado:* Satín.

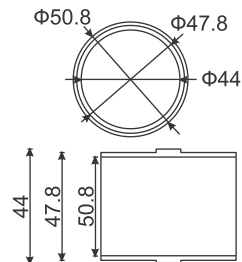

M312



Conector tubo a tubo 180°.

- *Para:* Tubo de 1.5".
- *Material:* Acero inox. 304.
- *Acabado:* Satín.

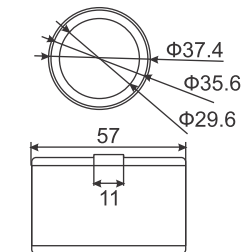

M309



Conector tubo a tubo articulado de 90° a 180°.

- *Para:* Tubo de 1.5".
- *Material:* Acero inox. 304.
- *Acabado:* Satín.

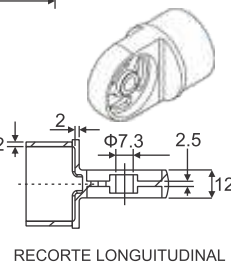
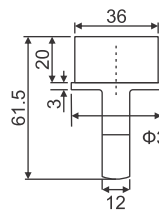
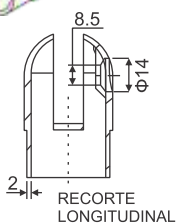
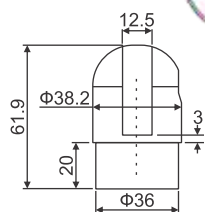
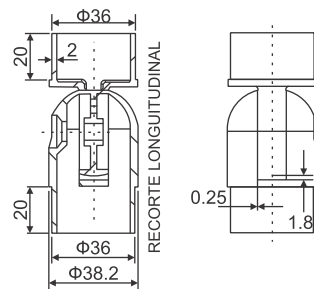

CONECTORES

Medidas en mm.

M109



Conector tubo a tubo articulado de 90° a 180°.

- *Para:* Tubo de 2".
- *Material:* Acero inox. 304.
- *Acabado:* Satín.

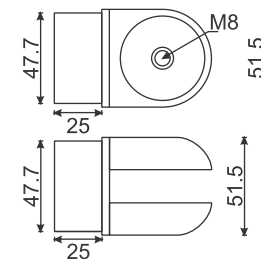

M101



Conector tubo a tubo 90°.

- *Para:* Tubo de 2".
- *Material:* Acero inox. 304.
- *Acabado:* Satín.

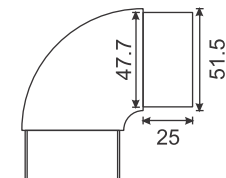

M301



Conector tubo a tubo 90°.

- *Para:* Tubo de 1.5".
- *Material:* Acero inox. 304.
- *Acabado:* Satín.

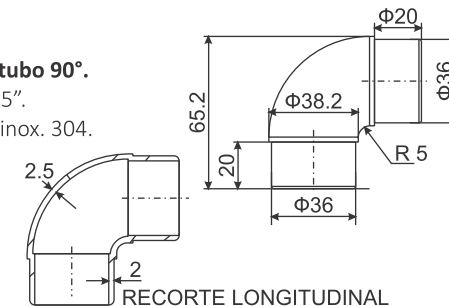

C012



Conector muro a vidrio.

- *Material:* Acero inox. 304.
- *Acabado:* Satín.

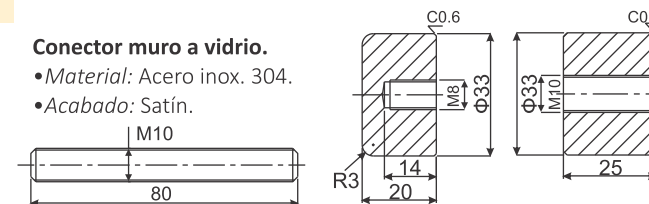

TC012



Taquete para conector C012.

- *Material:* Acero inox. 304.
- *Acabado:* Satín.

CONECTORES Y TAPONES

Medidas en mm.

C012-L



Conector muro a vidrio.
 •Material: Acero inox. 304.
 •Acabado: Satín.

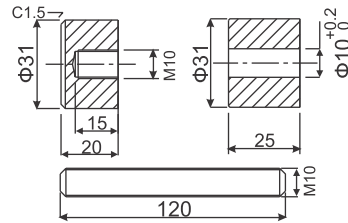

TC012-L-M10



Taquete para C012-L.
 •Material: Hierro.
 •Acabado: Tropicalizado.

C013



Conector muro a vidrio.
 •Material: Acero inox. 304.
 •Acabado: Satín.

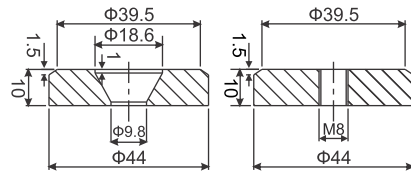

C014



Conector muro a vidrio con taquete.
 •Material: Acero inox. 304.
 •Acabado: Satín.

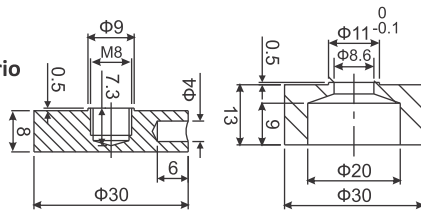

M126



Conector articulado para barandal.
 •Para: Tubo de 2".
 •Material: Acero inox. 304.
 •Acabado: Satín.

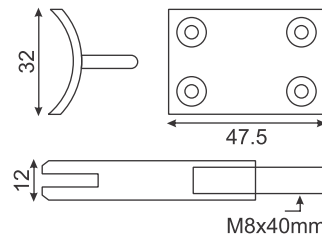

M125H



Tapón para conector de rosca.
 •Para: Tubo de 2".
 •Material: Acero inox. 304.
 •Acabado: Satín.

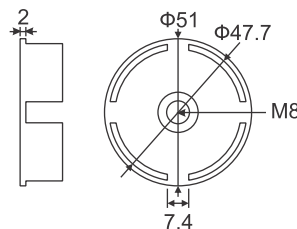

TAPONES Y BRIDAS

Medidas en mm.

M125



Tapón para poste.
 •Para: Tubo de 2".
 •Material: Acero inox. 304.
 •Acabado: Satín.

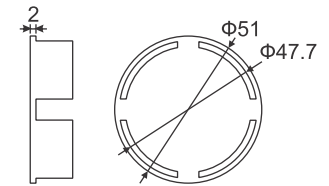

M128



Tapón para poste terminación ovalada.
 •Para: Tubo de 2".
 •Material: Acero inox. 304.
 •Acabado: Satín.

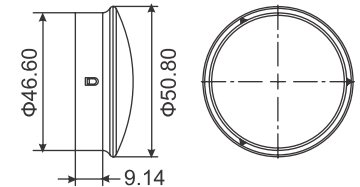

M325



Tapón para poste.
 •Para: Tubo de 1.5".
 •Material: Acero inox. 304.
 •Acabado: Satín.

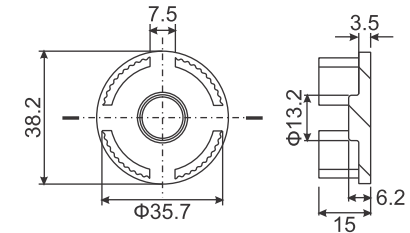

M075



Brida sin cuello.
 •Para: Tubo de 2".
 •Material: Acero inox. 304.
 •Acabado: Satín.

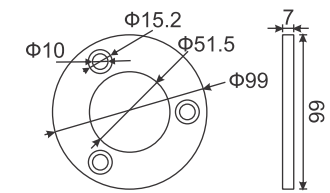

PH001-SN



Brida con cuello para tubo.
 •Para: 1.5".
 •Material: Acero inox. 304.
 •Acabado: Satín.

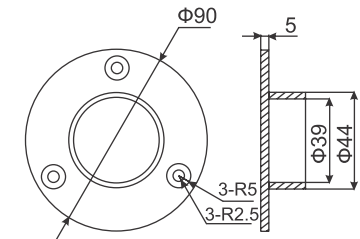

PH002-SN



Brida con cuello para tubo.
 •Para: 2".
 •Material: Acero inox. 304.
 •Acabado: Satín.

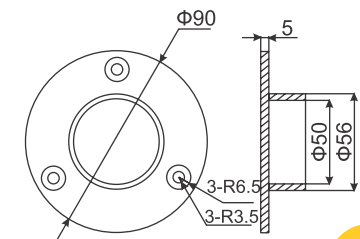

TAPAS, POSTES Y CLIPS

Medidas en mm.

M090



Tapa de base redonda para poste.

- Para: Tubo de 2".
- Material: Acero inox. 304.
- Acabado: Satín.

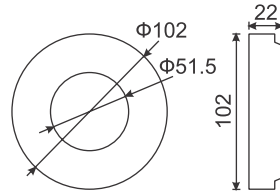

PH003-SN



Poste para barandal con cuello y tapa.

- Para: 1.5".
- Material: Acero inox. 304.
- Acabado: Satín.

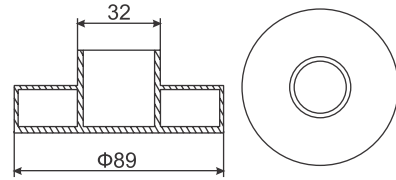

PH005-SN



Poste para barandal con cuello y tapa.

- Para: 2".
- Material: Acero inox. 304.
- Acabado: Satín.

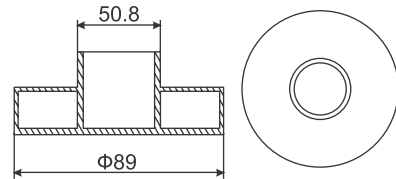

K-869-C • K-869-S



Clip de fijación base curva.

- Para: 6-10 mm.
- Soporta: 30 kg.
- Material: Acero inox. 304.
- Acabado: K-869-C Cromo. K-869-S Satín.

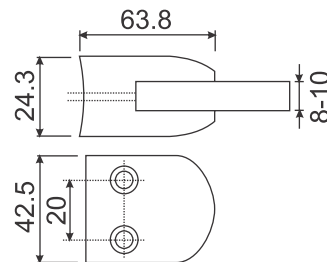

K-870-C • K-870-S



Clip de fijación base plana.

- Para: 6-10 mm.
- Soporta: 30 kg.
- Material: Acero inox. 304.
- Acabado: K-870-C Cromo. K-870-S Satín.

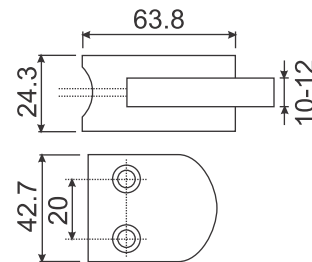

CLIPS

Medidas en mm.

K-869Z-S



Clip de fijación ancho base curva.

- Para: 6-12 mm.
- Soporta: 30 kg.
- Material: Zamac.
- Acabado: Satín.

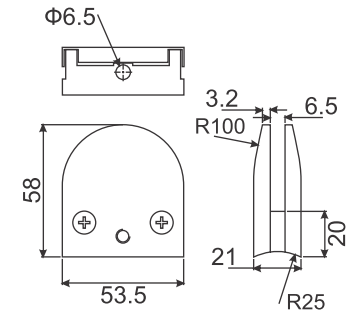

K-870Z-S



Clip de fijación ancho base plana.

- Para: 6-12 mm.
- Soporta: 30 kg.
- Material: Zamac.
- Acabado: Satín.

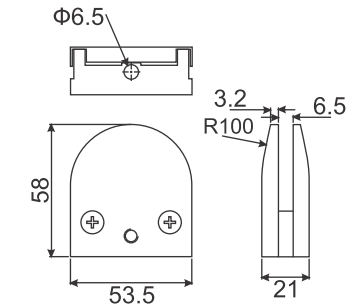

P-871



Clip de fijación ancho base curva.

- Para: 6-12 mm.
- Soporta: 30 kg.
- Material: Zamac.
- Acabado: Satín.

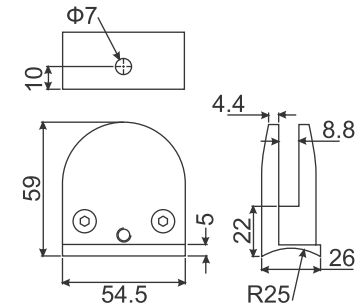

P-872



Clip de fijación ancho base plana.

- Para: 6-12 mm.
- Soporta: 30 kg.
- Material: Zamac.
- Acabado: Satín.

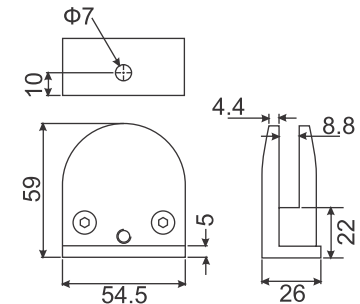

ALETAS

Medidas en mm.

F001



Aleta.

- De: 2.5 m.
- Para: 10 mm.
- Material: PVC.

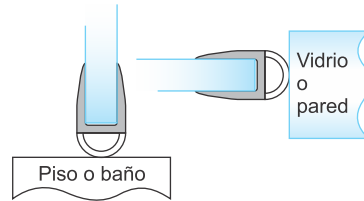

F002



Aleta.

- De: 2.5 m.
- Para: 10 mm.
- Material: PVC.

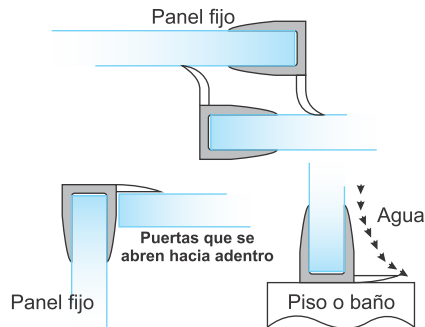

F004



Aleta.

- De: 2.5 m.
- Para: 6-15 mm.
- Material: PVC.

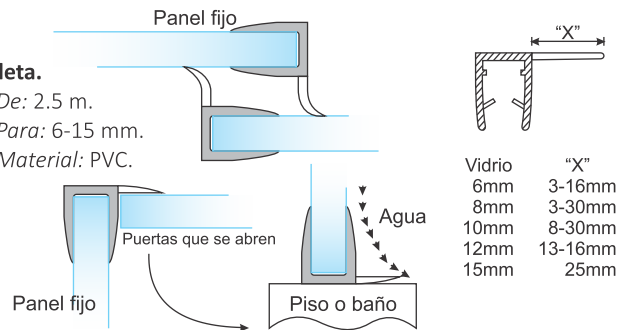

F005

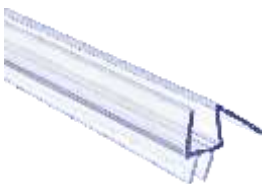

Aleta.

- De: 2.5 m.
- Para: 8-12 mm.
- Material: PVC.

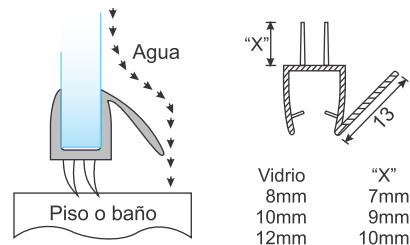

F08



Aleta con magneto.

- De: 2.5 m.
- Para: 10 mm.
- Material: PVC con magneto.

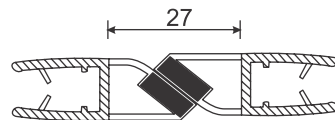

CONECTORES

Medidas en mm.

C101



Conector rectangular de esquina.

- Para: 8-10 mm.
- Material: Aluminio.
- Acabado: Satín.

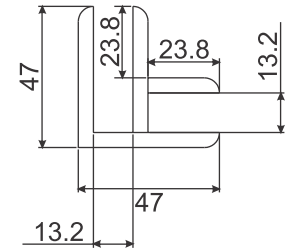

C102



Conector vidrio a vidrio.

- Para: 8-10 mm.
- Material: Acero inox. 304.
- Acabado: Satín.

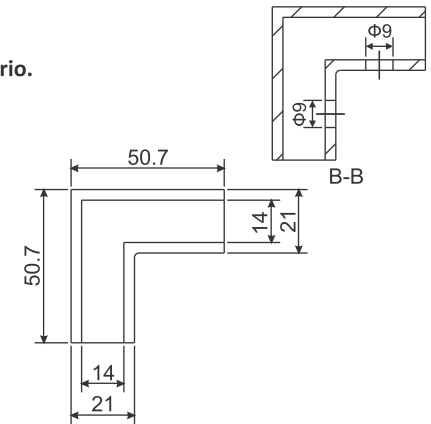
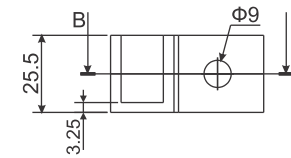

C103



Conector muro a vidrio derecho.

- Para: 8-10 mm.
- Material: Acero inox. 304.
- Acabado: Satín.

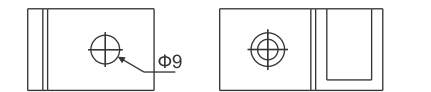
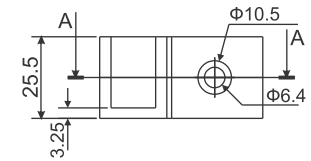

C104



Conector muro a vidrio izquierdo.

- Para: 8-10 mm.
- Material: Acero inox. 304.
- Acabado: Satín.

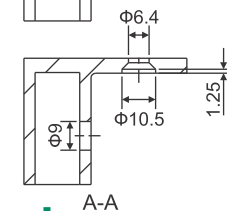
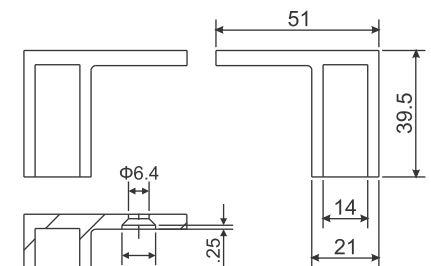

CONECTORES

Medidas en mm.

C105



Conector ajustable.

- Para: 8-10 mm.
- Material: Acero inox. 304.
- Acabado: Satín.

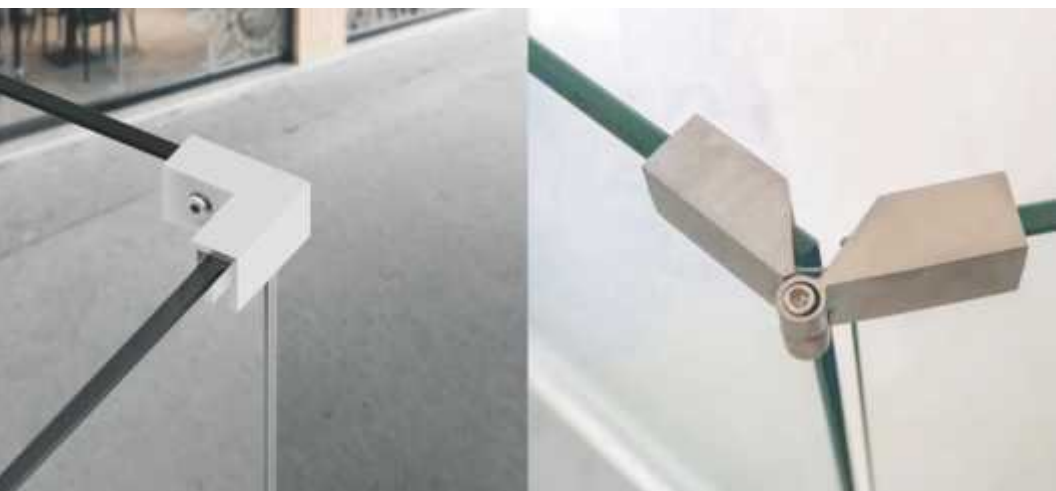
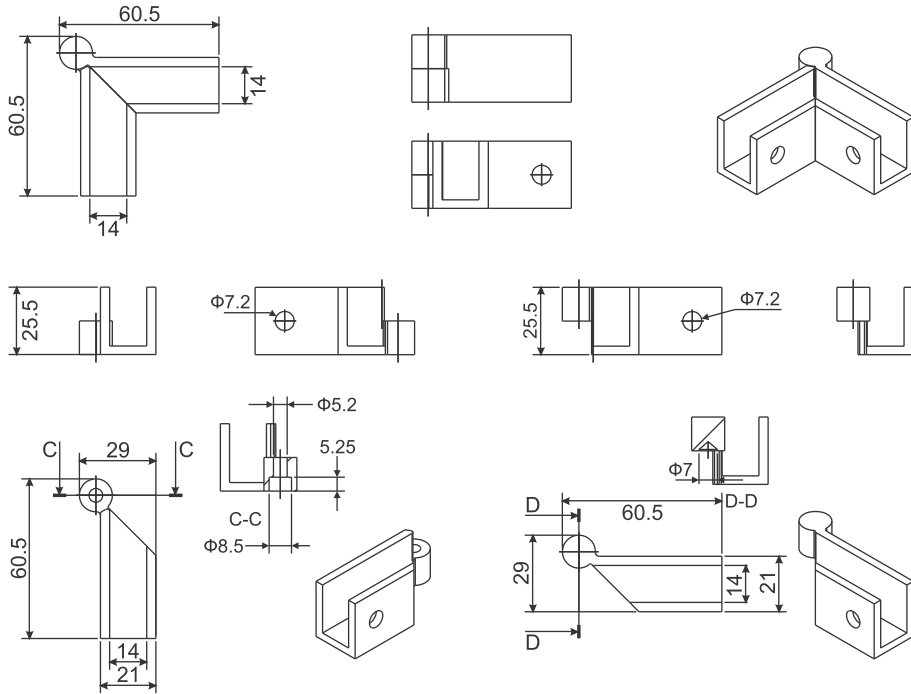

MINI POSTES

Medidas en mm.

M100



Mini Poste.

- De: 25 cm.
- Para: 8-12 mm.
- Diámetro: 1 1/4".
- Material: Acero inox. 304.
- Acabado: Satín.

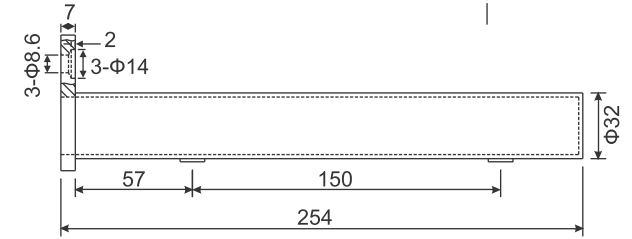
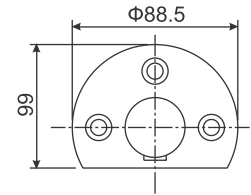

M100-L



Mini Poste.

- De: 50 cm.
- Para: 8-12 mm.
- Diámetro: 1 1/4".
- Material: Acero inox. 304.
- Acabado: Satín.

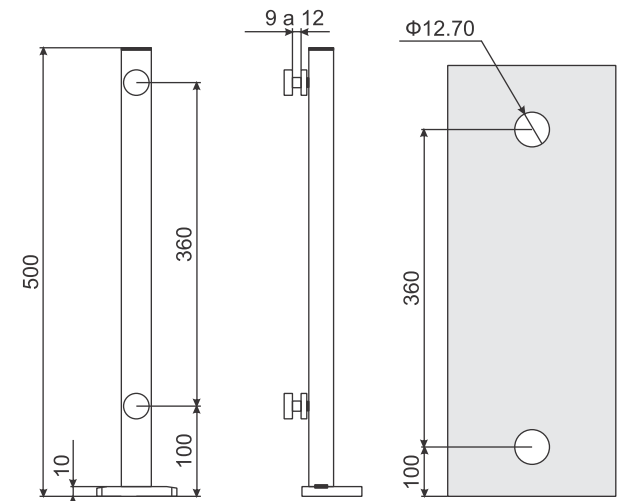
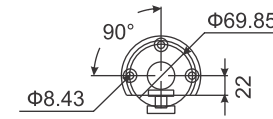

BARRENADO

GRAPA RECTANGULAR

Medidas en mm.

M155



Grapa rectangular.

- Para: 8-12 mm.
- Material: Acero inox. 304.
- Acabado: Satin.

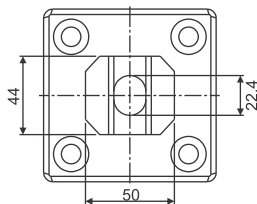
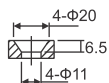
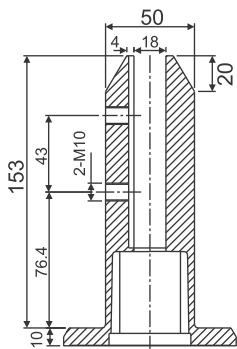
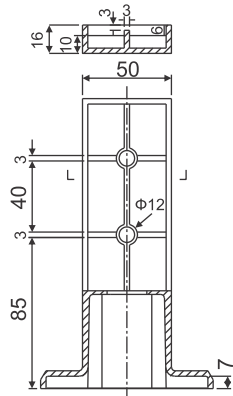
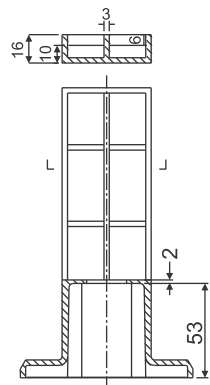
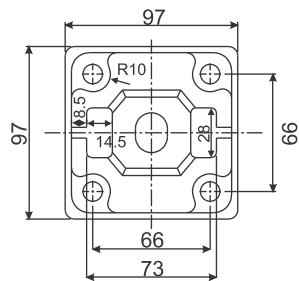

GRAPA REDONDA CONECTOR

Medidas en mm.

M156



Grapa redonda.

- Para: 8-12 mm.
- Material: Acero inox. 304.
- Acabado: Satin.

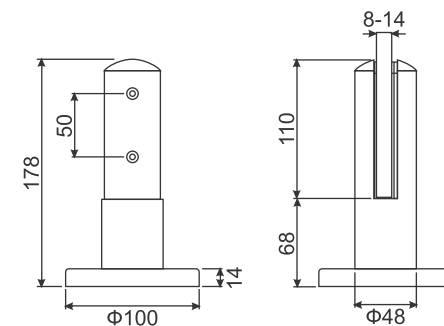

HN06



Conector.

- Para: 8-12 mm.
- Material: Acero inox. 304.
- Acabado: Satin.

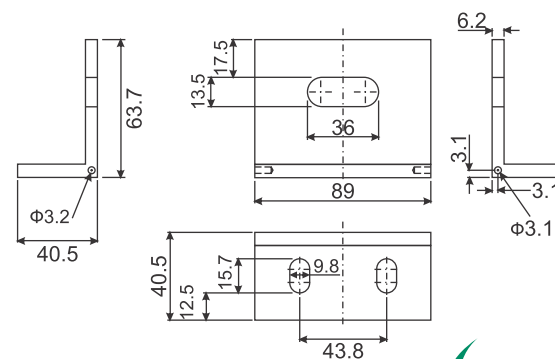
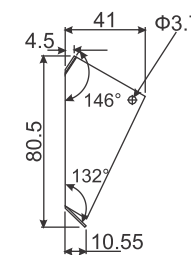
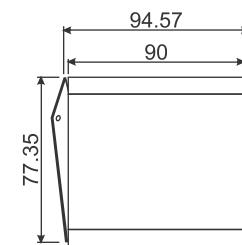
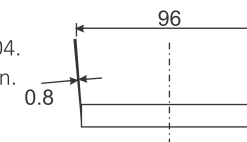

PUNTO DE GIRO CERRADURA DE ESQUINA

Medidas en mm.

A-607



Punto de giro superior.

- Material: Acero inox. 304.
- Acabado: Satín.

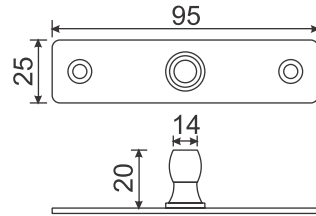

D-050



Cerradura de esquina

- Para: 8-12 mm.
- Material: Acero inox. 304.
- Acabado: Satín.

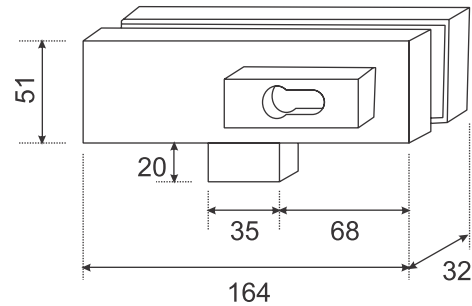

CORTE DE VIDRIO



HERRAJES

Medidas en mm.

D-020



Herraje superior.

- Para: 8-12 mm.
- Material: Acero inox. 304.
- Acabado: Satín.

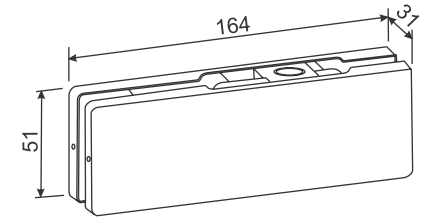

CORTE DE VIDRIO

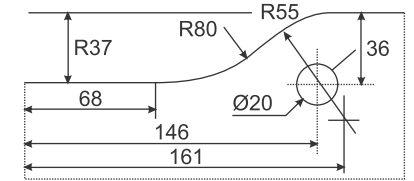

D-010



Herraje inferior.

- Para: 8-12 mm.
- Material: Acero inox. 304.
- Acabado: Satín.

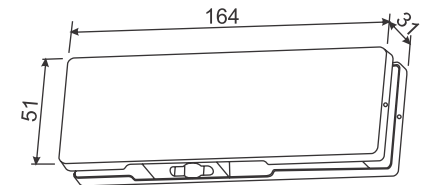

CORTE DE VIDRIO

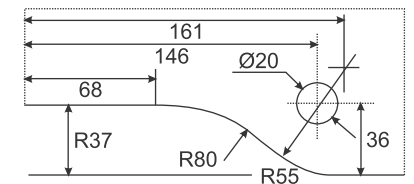

BISAGRAS HIDRÁULICAS

Medidas en mm.

B-322



Bisagra hidráulica de piso entrada rectangular.

- Para: Puerta máx. 1 m.
- Soporta: 130 kg.
- Acabado: Satín.

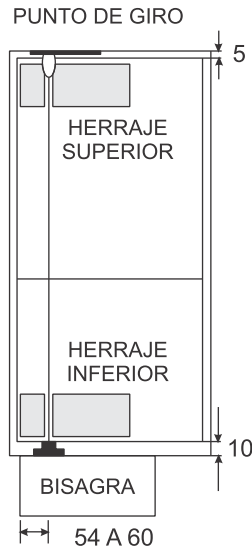
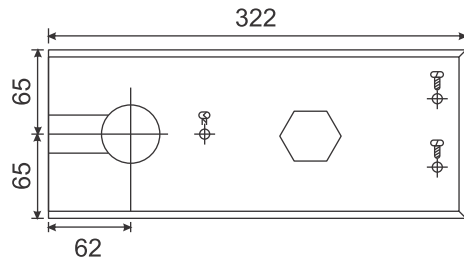

B200-B



Bisagra hidráulica de piso entrada rectangular.

- Para: Puerta máx. 1 m.
- Soporta: 80 kg.
- Acabado: Satín.

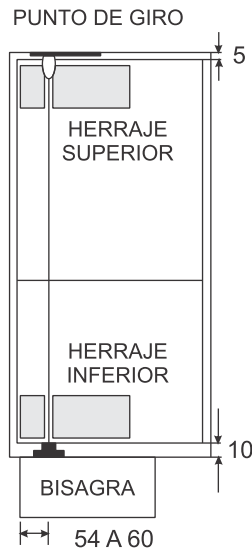
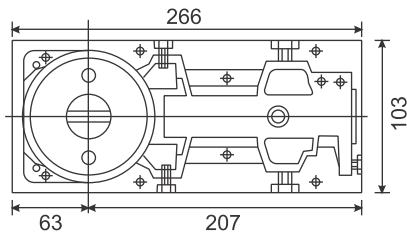

HERRAJES

Medidas en mm.

D030-B



Herraje superior para antepecho.

- Para: 8-12 mm.
- Material: Acero inox. 304.
- Acabado: Satín.

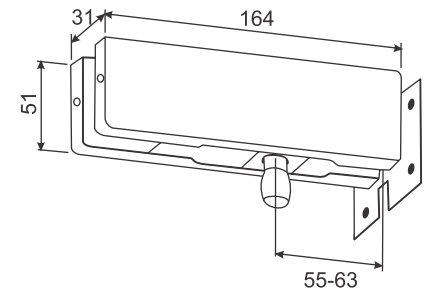

CORTE DE VIDRIO

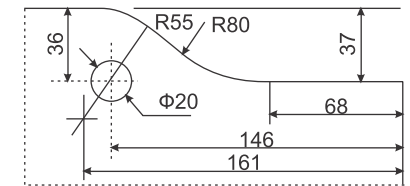

D040



Herraje superior aleta.

- Para: 8-12 mm.
- Material: Acero inox. 304.
- Acabado: Satín.

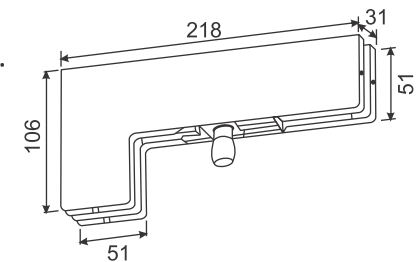

CORTE DE VIDRIO

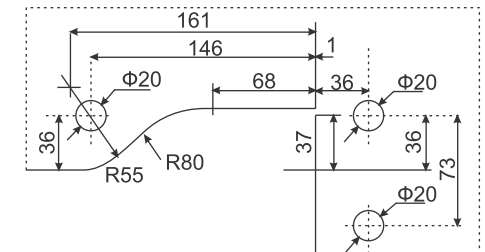

HERRAJES SISTEMA HIDRÁULICO

Medidas en mm.

ZJ-020



Herraje superior.

- Para: 8-12 mm.
- Material: Acero inox. 304.
- Acabado: Satín.

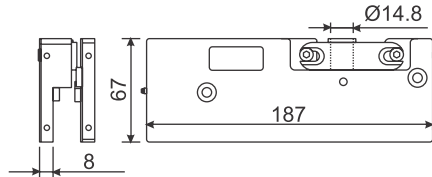

HP-L



Sistema hidráulico sin poso.

- Para: 8-12 mm.
- Puerta máx. 1 m.
- Soporta: 100 kg.
- Acabado: Satín
- No necesita bisagra hidráulica.

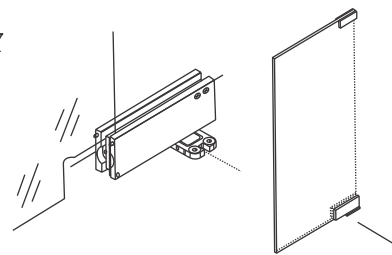
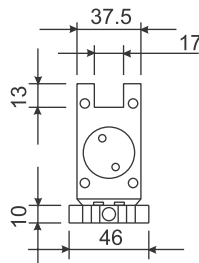
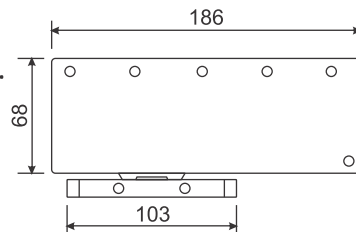

CONECTORES

Medidas en mm.

XH091



Conector muro a tubo.

- Para: 3/4".
- Material: Zamac.
- Acabado: Satín.

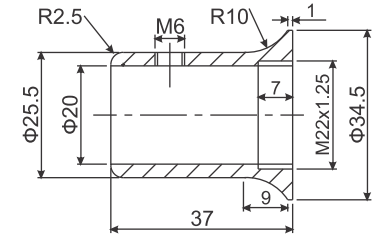

XH092



Conector ajustable vidrio a tubo.

- Para: 3/4".
- Material: Zamac.
- Acabado: Satín.

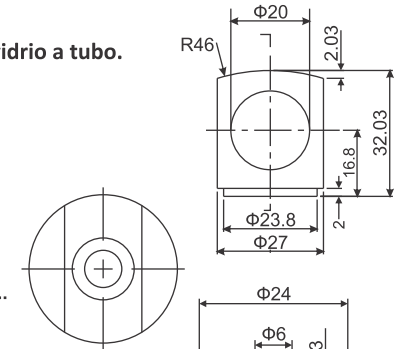

XH093



Conector ajustable vidrio a tubo.

- Para: 3/4".
- Material: Zamac.
- Acabado: Satín.

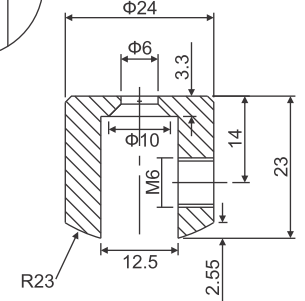

XH094



Conector ajustable tubo a tubo.

- Para: 3/4".
- Material: Zamac.
- Acabado: Satín.

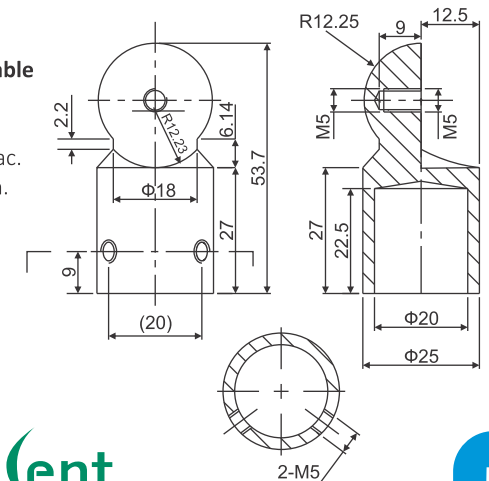

CONECTORES

Medidas en mm.

XH095



Conector muro a tubo 45°.

- Para: 3/4".
- Material: Aluminio.
- Acabado: Satín.

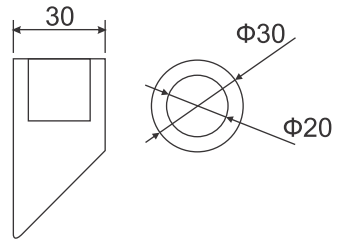

XH096



Conector tubo a tubo 90°.

- Para: 3/4".
- Material: Zamac.
- Acabado: Satín.

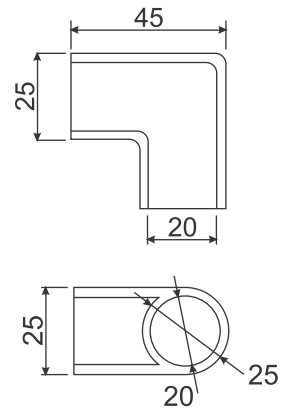

SISTEMAS CORREDIZOS CERRADURAS

Medidas en mm.

KH01-B

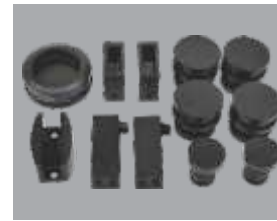

Sistema corredizo sin tubo.

- Para: 8-10 mm.
- Material: Acero inox. 304.
- Acabado: Negro mate.

KH02-B

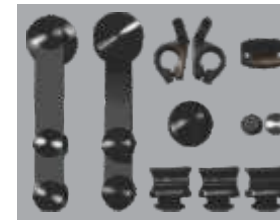

Sistema corredizo sin tubo.

- Para: 10-12 mm.
- Material: Acero inox. 304.
- Acabado: Negro mate.

N0115-B



Escuadra para sistema corredizo.

- Material: Acero inox. 304.
- Acabado: Negro mate.

O2-B



Tubo (riel) cuadrado para sistema corredizo

- Tamaño: 10 x 30 mm
- Largo: 2 m
- Calibre: 16
- Compatible: KH01-B
- Material: Acero inox. 304.
- Acabado: Negro mate.

XH-82801-B



Cerradura de puerta de cristal de mariposa.

- Para: 8-12 mm.
- Material: Acero inox. 304.
- Acabado: Negro mate.

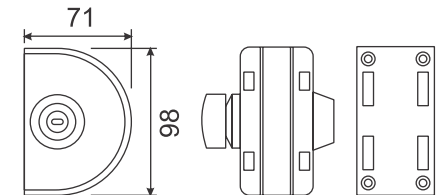

XH-82803-B



Cerradura de puerta de cristal doble de mariposa.

- Para: 8-12 mm.
- Material: Acero inox. 304.
- Acabado: Negro mate.

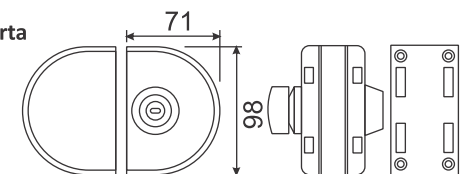

CERRADURAS JALADERAS

Medidas en mm.

XH-83101-B



- Cerradura con mango.**
- Para: 8-12 mm.
 - Material: Acero inox. 304.
 - Acabado: Negro mate.

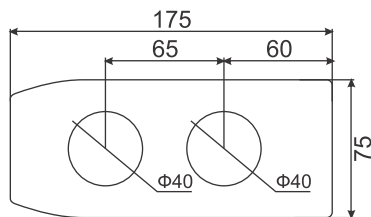

XH-83102P-B



- Contra para cerradura con mango.**
- Para: 8-12 mm.
 - Material: Acero inox. 304.
 - Acabado: Negro mate.

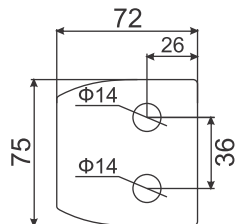

K-247-B



- Jaladera 30*30.**
- Material: Aluminio.
 - Acabado: Negro mate

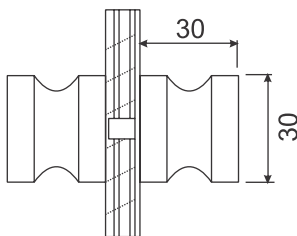

25*300-B



- Jaladera de 30.**
- Para: 8-12 mm.
 - Material: Acero inox. 304.
 - Acabado: Negro mate.

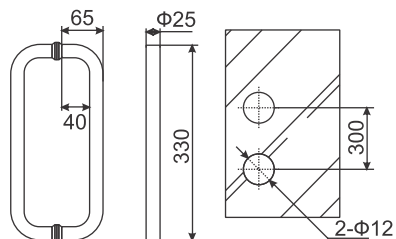

19*150-B



- Jaladera de 15.**
- Para: 8-12 mm.
 - Material: Acero inox. 304.
 - Acabado: Negro mate.

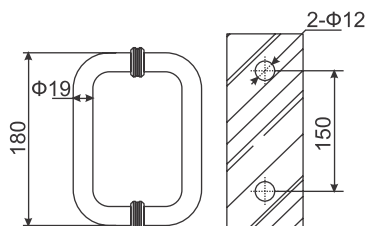

JALADERAS Y CLIPS

Medidas en mm.

SH-250-50-B • SH-250-90-B • SH-250-120-B • SH-250-150-B



Jaladera tipo H de 1-1/4.

- Material: Acero inox. 304.
- Acabado: Negro mate.
- SH-250-50-B (50 cm) centros a 30 cm.
- SH-250-90-B (90 cm) centros a 50 cm.
- SH-250-120-B (120 cm) centros a 80 cm.
- SH-250-150-B (150 cm) centros a 100 cm.

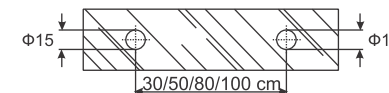

SH-530-20*45-B



- Jaladera toallero 20*45**
- Material: Acero inox. 304.
 - Acabado: Negro mate.

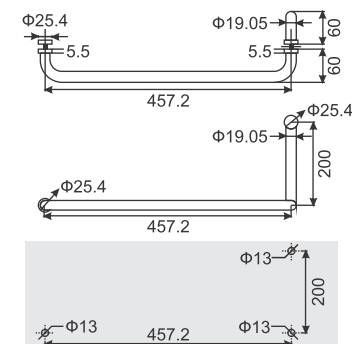

K-169-B



- Clip.**
- Para: 5-15 mm.
 - Soporta: 25 kg.
 - Material: Zamac.
 - Acabado: Negro mate.

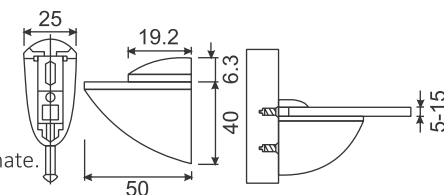

K-170-B



- Clip.**
- Para: 5-25 mm.
 - Soporta: 35 kg.
 - Material: Zamac.
 - Acabado: Negro mate.

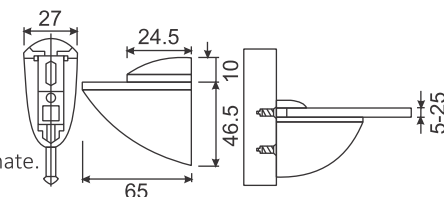

CLIPS

Medidas en mm.

K-512-B



Clip 180°.

- Para: 8-10 mm.
- Soporta: 50 kg.
- Material: Acero inox. 304.
- Acabado: Negro mate

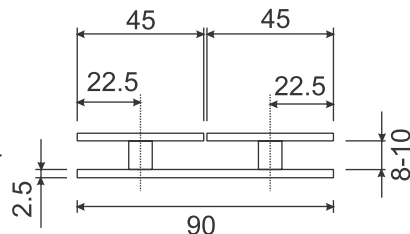

K-518-B



Clip.

- Para: 8-10 mm.
- Soporta: 50 kg.
- Material: Acero inox. 304.
- Acabado: Negro mate

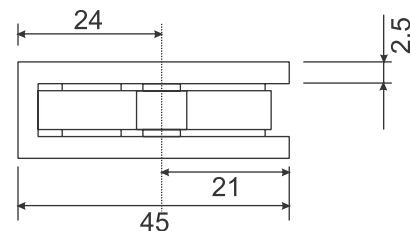

K-507-B



Clip 90°.

- Para: 8-10 mm.
- Soporta: 50 kg.
- Material: Acero inox. 304.
- Acabado: Negro mate.

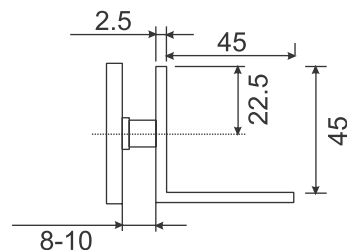

K-508-B



Clip 90°.

- Para: 8-10 mm.
- Soporta: 50 kg.
- Material: Acero inox. 304.
- Acabado: Negro mate.

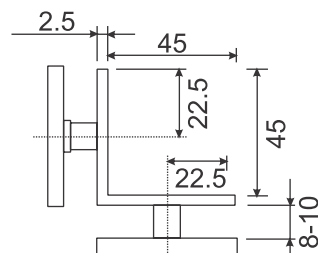

K-869Z-B



Clip de fijación ancho base curva.

- Para: 6-12 mm.
- Soporta: 30 kg.
- Material: Zamac.
- Acabado: Negro mate.

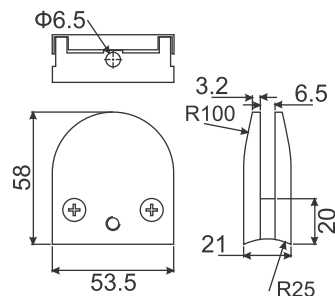

CLIPS Y BISAGRAS

Medidas en mm.

K-870Z-B



Clip de fijación ancho base plana.

- Para: 6-12 mm.
- Soporta: 30 kg.
- Material: Zamac.
- Acabado: Negro mate.

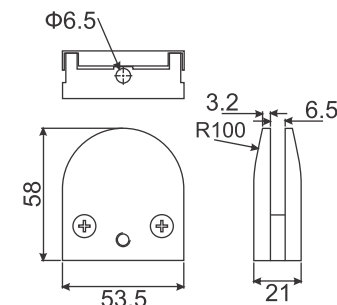

SH310-B



Bisagra muro a cristal desfasada.

- Para: 8-12 mm.
- Soporta: 25 kg.
- Material: Acero inox. 304.
- Acabado: Negro mate.

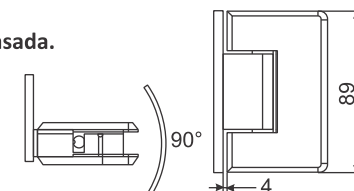

SH320-B



Bisagra muro a cristal centrada.

- Para: 8-12 mm.
- Soporta: 25 kg.
- Material: Acero inox. 304.
- Acabado: Negro mate.

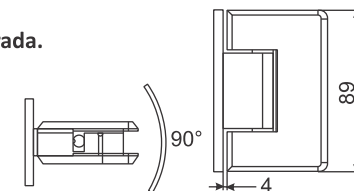

MODELOS SH310-B / SH320-B

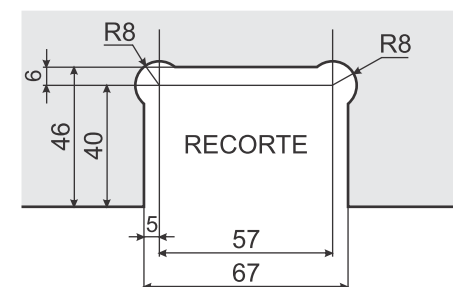

BISAGRAS

Medidas en mm.

SH330-B



Bisagra cristal a cristal 180°.

- Para: 8-12 mm.
- Soporta: 25 kg.
- Material: Acero inox. 304.
- Acabado: Negro mate.

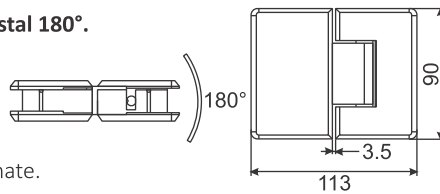

SH340-B



Bisagra cristal a cristal 135°.

- Para: 8-12 mm.
- Soporta: 25 kg.
- Material: Acero inox. 304.
- Acabado: Negro mate.

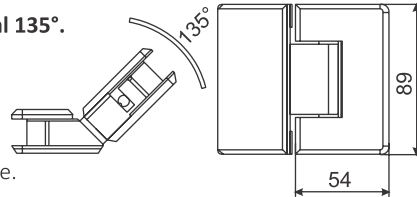

SH350-B



Bisagra cristal a cristal 90°.

- Para: 8-12 mm.
- Soporta: 25 kg.
- Material: Acero inox. 304.
- Acabado: Negro mate.

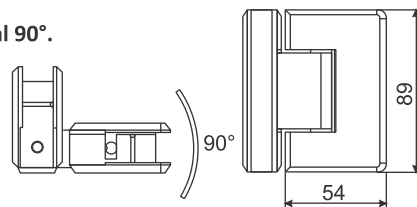

MODELOS SH330-B / SH340-B / SH350-B

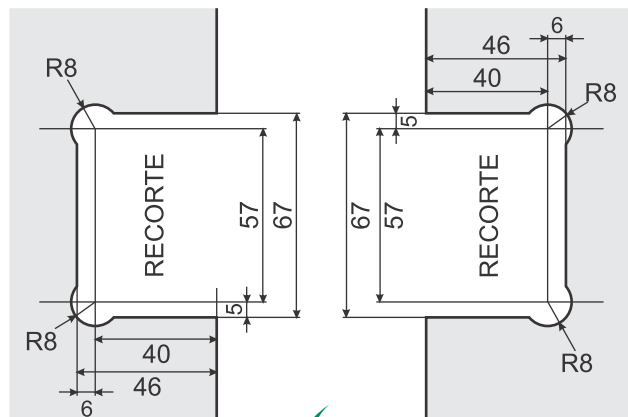

BISAGRAS

Medidas en mm.

SH300-B



Bisagra pivotante.

- Para: 8-12 mm.
- Soporta: 25 kg.
- Material: Acero inox. 304.
- Acabado: Negro mate.

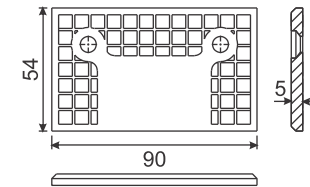

MODELO SH300-B

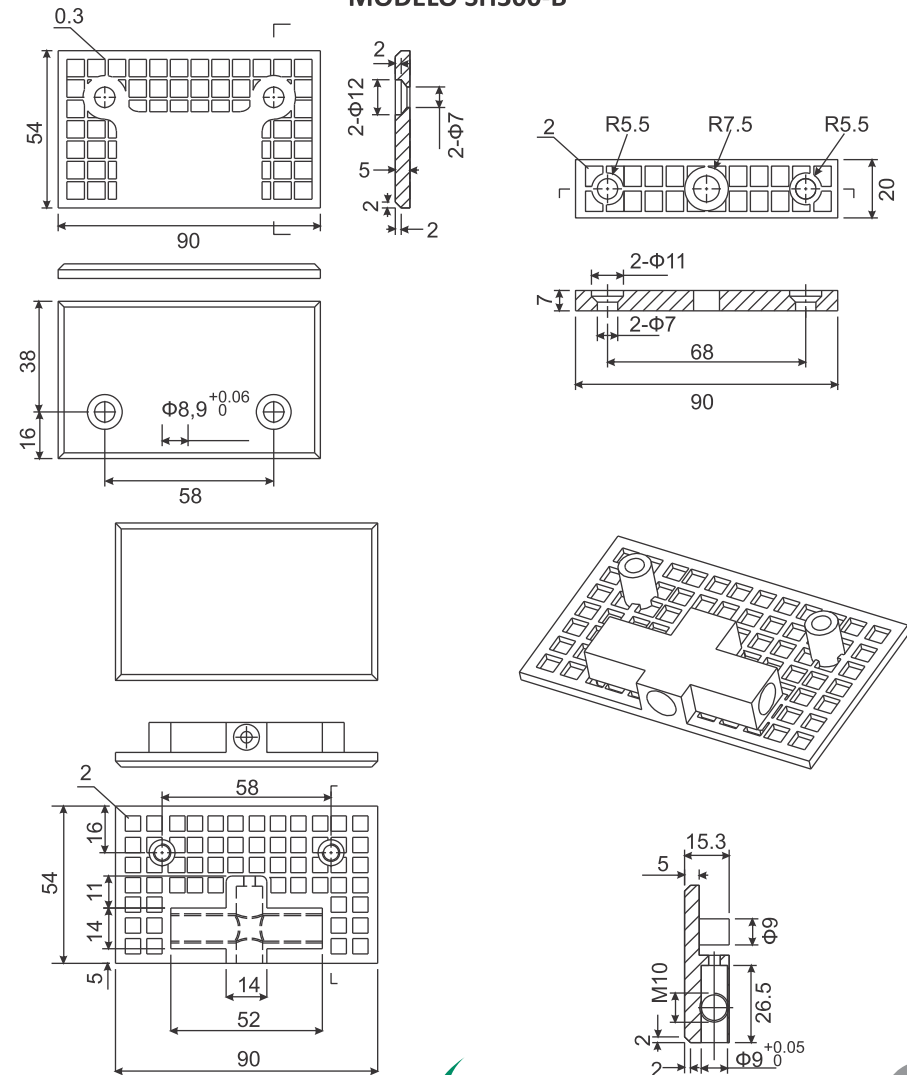

CERRADURA DE ESQUINA HERRAJES

Medidas en mm.

D-050-B



Cerradura de esquina

- Para: 8-12 mm.
- Material: Acero inox. 304.
- Acabado: Negro mate.

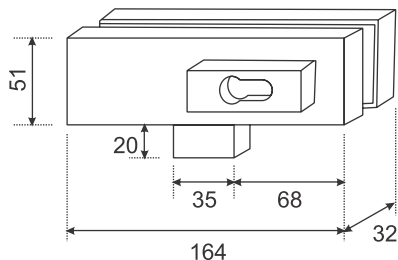

CORTE DE VIDRIO



D-020-B



Herraje superior.

- Para: 8-12 mm.
- Material: Acero inox. 304.
- Acabado: Negro mate.

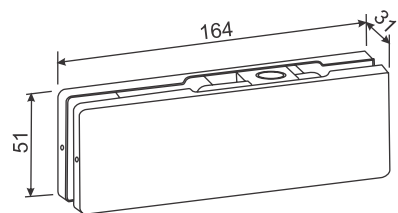

CORTE DE VIDRIO

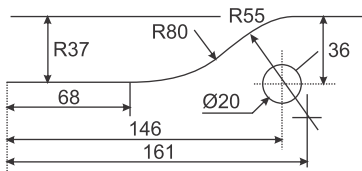

D-010-B



Herraje inferior.

- Para: 8-12 mm.
- Material: Acero inox. 304.
- Acabado: Negro mate.

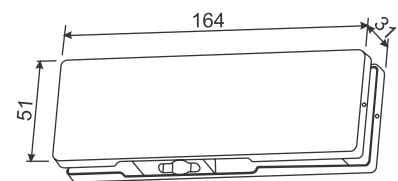

CORTE DE VIDRIO

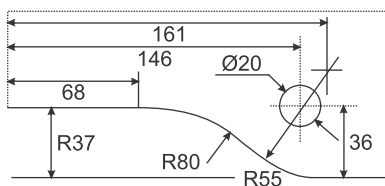

TAPA PARA BISAGRA HIDRAÚLICA DE PISO

Medidas en mm.

CB-322-B



Tapa para bisagra hidráulica de piso entrada rectangular.

- Para: Puerta máx. 1 m.
- Soporta: 130 kg.
- Acabado: Negro Mate.

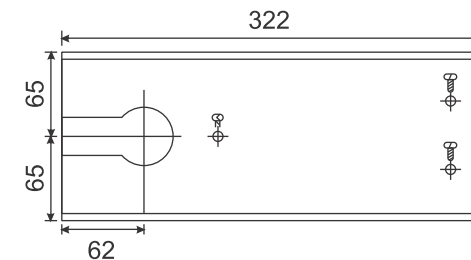

SISTEMAS CORREDIZOS JALADERAS

Medidas en mm.

KH01-G



Sistema corredizo sin tubo.

- Para: 8-10 mm.
- Material: Acero inox. 304.
- Acabado: Oro.

N0115-G



Escuadra para sistema corredizo.

- Material: Acero inox. 304
- Acabado: Oro.

O2-G



Tubo (riel) cuadrado para sistema corredizo

- Tamaño: 10 x 30 mm con un largo de 2m.
- Calibre: 16
- Compatible: KH01/KH01Z/KH01S
- Material: Acero inox. 304 con acabado oro.

K-247-G



Jaladera 30*30.

- Material: Aluminio.
- Acabado: Oro.

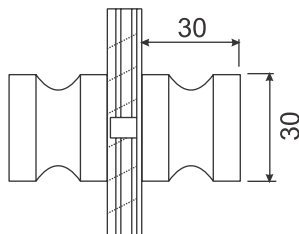

19*150-G



Jaladera de 15.

- Para: 8-12 mm.
- Material: Acero inox. 304.
- Acabado: Oro.

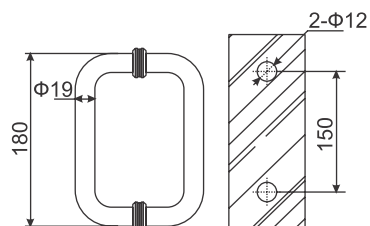

SH-250-50-G



Jaladera tipo H de 1-1/4.

- Material: Acero inox. 304.
- Acabado: Satín.
- SH-250-50 (50 cm) centros a 30 cm.

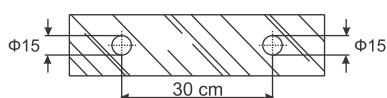

JALADERAS Y CLIPS

Medidas en mm.

SH-530-20*45-G

Jaladera toallero 20*45

- Material: Acero inox. 304.
- Acabado: Satín.

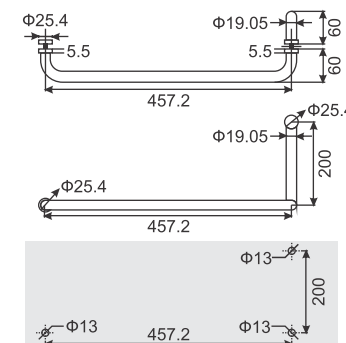

K-512-G



Clip 180°.

- Para: 8-10 mm.
- Soporta: 50 kg.
- Material: Acero inox. 304.
- Acabado: Oro.

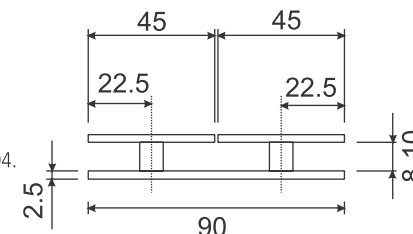

K-518-G



Clip.

- Para: 8-10 mm.
- Soporta: 50 kg.
- Material: Acero inox. 304.
- Acabado: Oro.

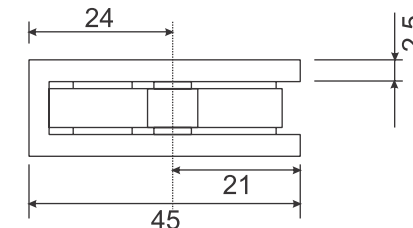

K-507-G



Clip 90°.

- Para: 8-10 mm.
- Soporta: 50 kg.
- Material: Acero inox. 304.
- Acabado: Oro.

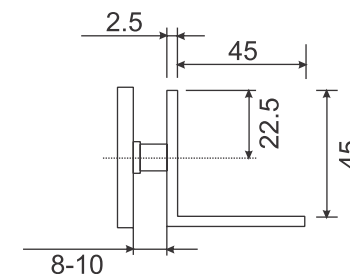

K-508-G



Clip 90°.

- Para: 8-10 mm.
- Soporta: 50 kg.
- Material: Acero inox. 304.
- Acabado: Oro.

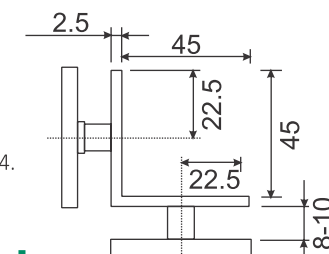

BISAGRAS

Medidas en mm.

SH320-G



Bisagra muro a cristal centrada.

- Para: 8-12 mm.
- Soporta: 25 kg.
- Material: Acero inox. 304.
- Acabado: Oro.

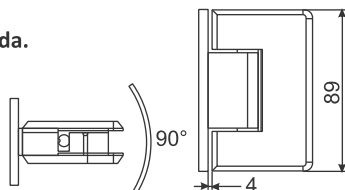

SH330-G

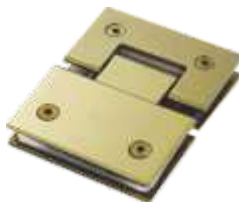

Bisagra cristal a cristal 180°.

- Para: 8-12 mm.
- Soporta: 25 kg.
- Material: Acero inox. 304.
- Acabado: Oro.

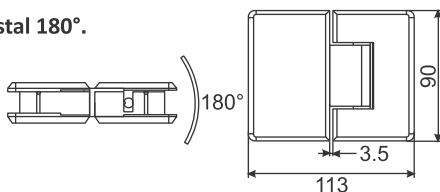

SH350-G



Bisagra cristal a cristal 90°.

- Para: 8-12 mm.
- Soporta: 25 kg.
- Material: Acero inox. 304.
- Acabado: Oro.

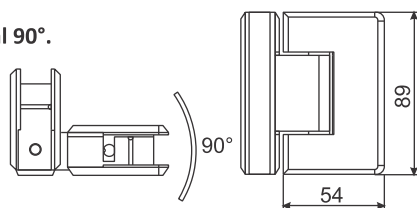

CARRETILLAS

Medidas en mm.

WR01



Carretilla tandem para línea europea, rodajas de nylon para 3".

- Para: máx. 80 kg.
- Material: Acero al carbón.
- Acabado: Pintura electrostática.

WR02



Carretilla para línea europea, balero nylon para 3".

- Para: máx. 50 kg.
- Material: Lámina de acero al carbón cal. 14.
- Acabado: Pintura electrostática.

WR09



Carretilla balero nylon para ventana y puerta corrediza 2".

- Para: máx. 25 kg.
- Material: Lámina de acero al carbón.
- Acabado: Pintura electrostática.

WR03



Carretilla para ventana corrediza, balero de nylon para 2".

- Para: máx. 10 kg.
- Material: Lámina de acero al carbón cal. 14.
- Acabado: Pintura electrostática.

WR04



Carretilla tipo europea, rodaja nylon para ventana y puerta corrediza 2".

- Para: máx. 25 kg.
- Material: Lámina de acero cal. 20.
- Acabado: Pintura electrostática.

WR05



Carretilla tipo europea para mosquitero, balero nylon 2".

- Para: máx. 12 kg.
- Material: Lámina de acero cal. 18.
- Acabado: Galvanizado.

WR20



Carretilla cola de ratón para mosquitero, rodaja nylon.

- Para: máx. 15 kg.
- Material: Lámina de acero templado.
- Acabado: Galvanizado.

WR06



Carretilla, balero nylon 2".

- Para: máx. 10 kg.
- Material: Acero al carbón.
- Acabado: Pintura electrostática.

WR10



Carretilla ensamble rápido, balero nylon 3".

- Para: máx. 30 kg.
- Material: Nylon.
- Acabado: Blanco.

CARRETILLAS

Medidas en mm.

WR12



Carretilla tandem ajustable, doble balero de nylon 1 1/4" para 3".

- Para: máx. 50 kg.
- Material: Acero al carbón.
- Acabado: Tropicalizado.

WR7



Carretilla con balero de nylon.

- Para: máx. 50 kg.
- Material: Acero al carbón.
- Acabado: Tropicalizado.

WR8



Carretilla con doble balero de nylon.

- Para: máx. 50 kg.
- Material: Acero al carbón.
- Acabado: Tropicalizado.

WR11



Carretilla española para baño baja.

- Para: máx. 25 kg.
- Material: Aluminio.
- Acabado: Galvanizado

WR13



Carretilla con doble rodaja de nylon para ventana doble Serie 3500.

- Para: máx. 50 kg.
- Material: Acero al carbón.
- Acabado: Tropicalizado.

WR15



Carretilla con rodaja de nylon Serie 3500.

- Para: máx. 50 kg.
- Material: Nylon.
- Acabado: Pintura electrostática.

WR16



Carretilla con balero de nylon e interior ajustable Serie 70 y 100 Eurovent.

- Para: máx. 50 kg.
- Material: Aluminio.
- Acabado: Pintura electrostática.

WR17



Carretilla ajustable con balero de nylon.

- Para: máx. 25 kg.
- Material: Zamac.
- Acabado: Tropicalizado.

CARRETILLAS

Medidas en mm.

WR23



Carretilla ajustable para mosquitero Serie 4000.

- Para: máx. 15 kg.
- Material: Plástico.
- Acabado: Pintura electrostática.

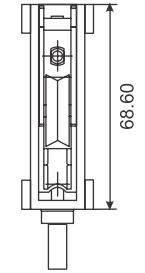
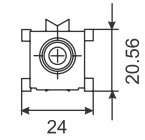
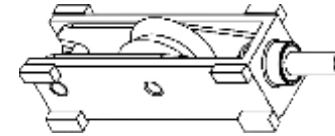

WR24



Carretilla ajustable Serie 4000.

- Para: máx. 50 kg.
- Material: Zamac.
- Acabado: Pintura electrostática.

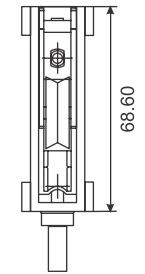
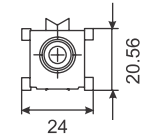
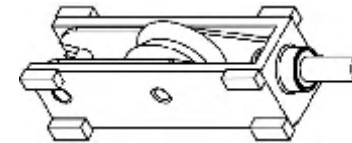

WR25



Carretilla ajustable doble rodaja Serie 4000.

- Para: máx. 75 kg.
- Material: Zamac.
- Acabado: Pintura electrostática.

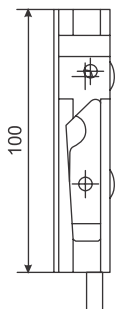
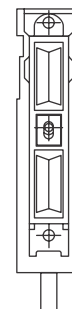
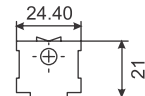

CARRETILLAS

Medidas en mm.

WR26



Carretilla ajustable Serie 4500.

- Para: máx. 75 kg.
- Material: Zamac.
- Acabado: Pintura electrostática.

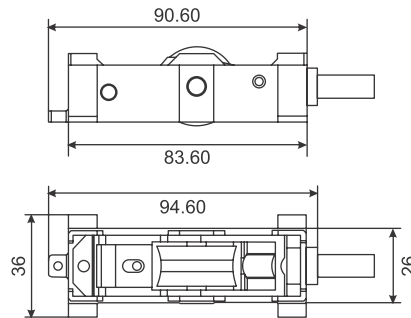
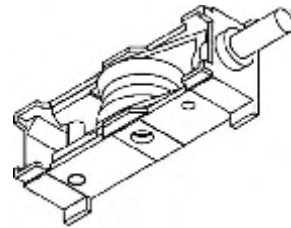

WR27



Carretilla ajustable doble rodaja Serie 4500.

- Para: máx. 90 kg.
- Material: Zamac.
- Acabado: Pintura electrostática.

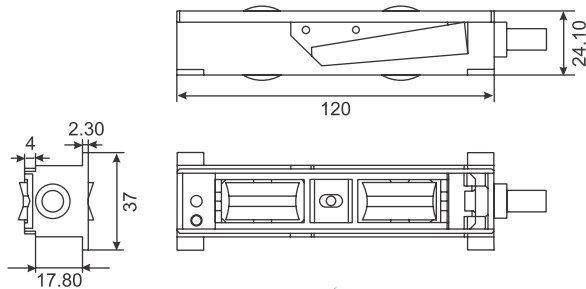
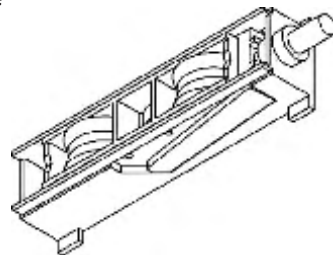

JALADERAS TOPES

Medidas en mm.

DL001



Jaladera reversible para venta de proyección tipo europea.

- Para: Ventana.
- Material: Aluminio.
- Acabado: DL001-W Blanco
DL001-B Negro
DL001-G Gris.

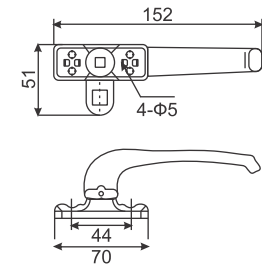

DS01



Tope media luna.

- Material: Acero inox. 304.
- Acabado: Satín.

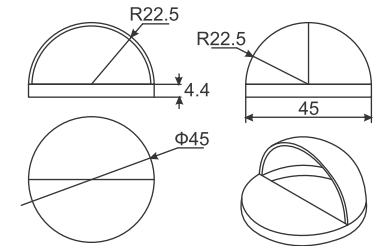

DS02



Tope chico.

- Material: Acero inox. 304.
- Acabado: Satín.

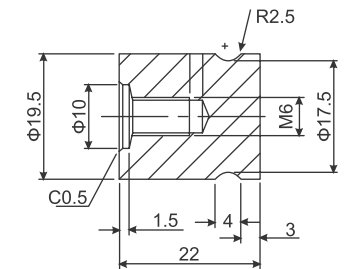

DS03



Tope grande.

- Material: Acero inox. 304.
- Acabado: Satín.

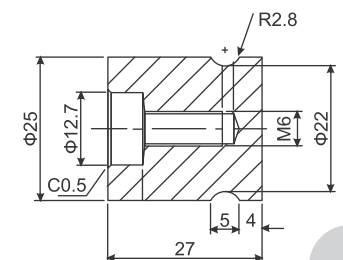

CHAPAS

Medidas en mm.

DL002



Chapa doble manija, tipo europea, llaves de alta seguridad, tapas y porta cilindros, manijas separadas.

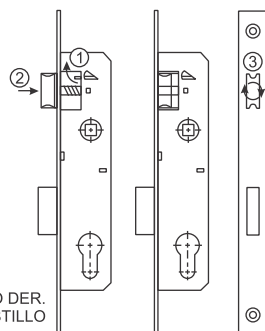
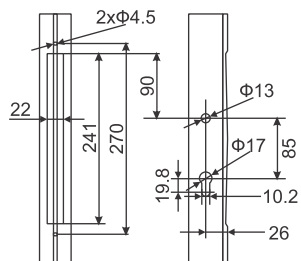

FÁCIL CAMBIO DE LADO IZQ. O DER. PRESIONE Y GIRE EL PESTILLO

- Para: Línea aluminio.
- Material: Cuerpo de acero, chapetón y contra de acero inox.
- Acabado: DL002-W Blanco.
DL002-B Negro.
DL002-G Gris.



DL003



Chapa de gancho.

- Para: Línea de 3".
- Material: Cuerpo de lámina y tapas de acero inox.
- Acabado: DL003-W Blanco.
DL003-B Negro.
DL003-G Gris.

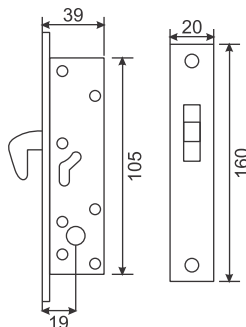

CHAPAS

Medidas en mm.

DL004



Chapa llave-llave con manija.

- Material: Cuerpo de acero y tapas de aluminio.
- Acabado: DL004-W Blanco.
DL004-B Negro.
DL004-G Gris.



MODELOS DL004 / DL005

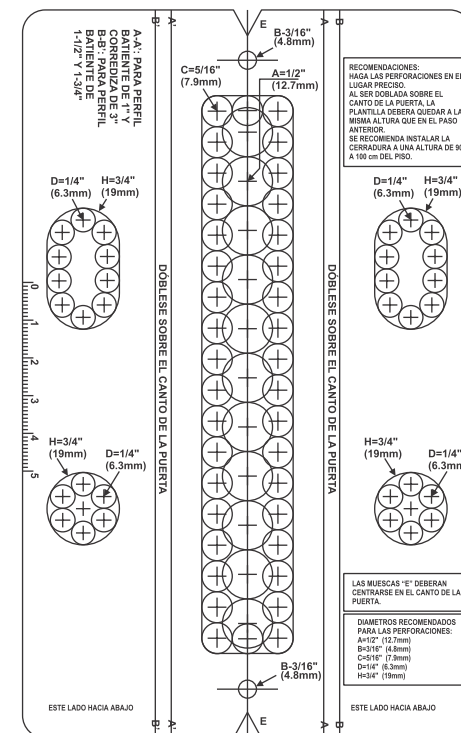

ESCALA AL 50%



DL005



Chapa llave-mariposa con manija.

- Material: Cuerpo de acero y tapas de aluminio.
- Acabado: DL005-W Blanco.
DL005-B Negro.
DL005-G Gris.

PASADORES Y JALADERAS

Medidas en mm.

DL006

Pasador de maroma.

- Material: Zamac.
- Acabado:
DL006-W Blanco.
DL006-B Negro.
DL006-G Gris.

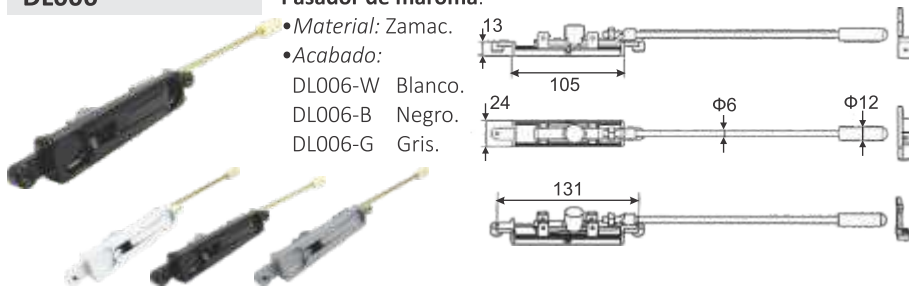

WL001

Jaladera de embutir.

- Para: Línea nacional de 2".
- Material: Aluminio.
- Acabado:
WL001-W Blanco.
WL001-B Negro.
WL001-G Gris.



WL002

Jaladera de embutir.

- Para: Línea nacional de 3".
- Material: Aluminio.
- Acabado:
WL002-W Blanco.
WL002-B Negro.
WL002-G Gris.



WL003

Jaladera de embutir.

- Para: Línea europea de 2".
- Material: Aluminio.
- Acabado:
WL003-W Blanco.
WL003-B Negro.
WL003-G Gris.



JALADERAS Y ESCUADRAS

Medidas en mm.

WL004

Jaladera de embutir.

- Para: Línea europea de 3".
- Material: Aluminio.
- Acabado:
WL004-W Blanco.
WL004-B Negro.
WL004-G Gris.



WL006

Jaladera de embutir sin tornillos.

- Para: Línea europea de 3".
- Material: Aluminio.
- Acabado:
WL004-W Blanco.
WL004-B Negro.
WL004-G Gris.

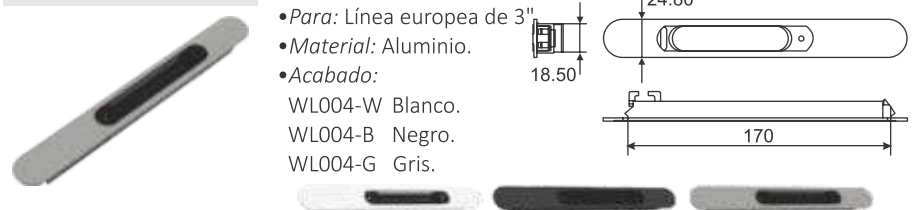

WL008

Jaladera de embutir con chapa.

- Para: Línea europea de 3".
- Material: Aluminio.
- Acabado:
WL004-W Blanco.
WL004-B Negro.
WL004-G Gris.



WR14



Escuadra para elaborar marcos mosquiteros

- De: 9.14 mm.
- Material: Lámina de aluminio cal. 14.
- Acabado: Satín.
- Venta múltiplos de 100.

WR14AL

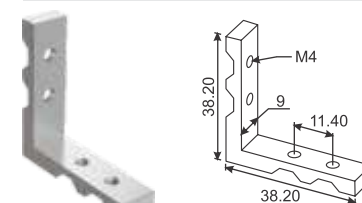

Escuadra de ángulo barrenada

- De: 10 mm.
- Material: Aluminio.
- Acabado: Natural.

BISAGRAS Y TIRADOR

Medidas en mm.

HN01



Bisagra para puertas y ventanas 3 palas
Línea Española 1400

- *Soporta:* 90 kg x par.
- *Material:* Aluminio.
- *Acabado:* HN01-B Negro.
HN01-W Blanco.
HN01-G Gris.

HN02



Bisagra para puertas y ventanas 2 palas
Línea Española 1400

- *Soporta:* 50 kg x par.
- *Material:* Aluminio.
- *Acabado:* HN02-B Negro.
HN02-W Blanco.
HN02-G Gris.

HN03



Bisagra para puerta y ventana

- *Soporta:* 50 kg x par.
- *Material:* Aluminio.
- *Acabado:* HN03-B Negro.
HN03-W Blanco.
HN03-G Gris.

HN04



Bisagra para puerta y ventana Eurovent Serie 35

- *Soporta:* 25 kg x par.
- *Material:* Aluminio.
- *Acabado:* HN04-B Negro.
HN04-W Blanco.
HN04-G Gris.

HN05



Bisagras tipo libro 3x3"

- *Material:* Aluminio.
- *Acabado:* HN05-B Negro.
HN05-W Blanco.
HN05-G Satín.
HN05-A Aluminio.

HN07

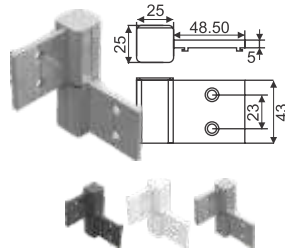

Bisagra para puerta batiente Eurovent Serie 70

- *Venta por par.*
- *Material:* Aluminio.
- *Acabado:* HN07-B Negro.
HN07-W Blanco.
HN07-G Gris.

HA01



Tirador

- *Material:* Aluminio.
- *Acabado:* HA01-B Negro.
HA01-W Blanco.
HA01-G Gris.

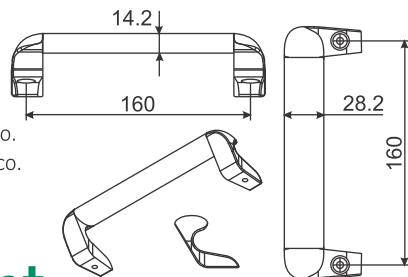

axlent
italy

BRAZOS DE PROYECCIÓN

Medidas en mm.

WS18-8-2 • WS18-12-2 • WS18-16-2 • WS18-20-2



Brazo de proyección inglés.

- *Material:* Acero inox. 304.
- *Acabado:* Satín.

- | | |
|-----------|-----|
| WS18-8-2 | 8" |
| WS18-12-2 | 12" |
| WS18-16-2 | 16" |
| WS18-20-2 | 20" |

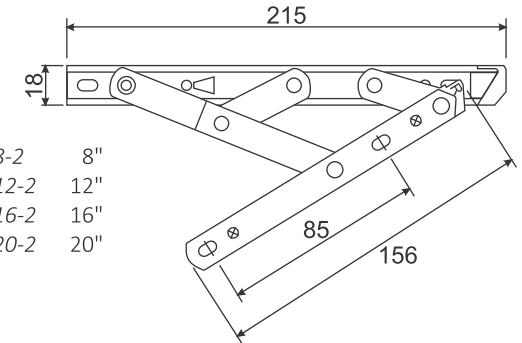

WR19-8-2 • WR19-12-2 • WR19-16-2 • WR19-20-2



Brazo de proyección nacional.

- *Material:* Acero inox. 304.
- *Acabado:* Satín.

- | | |
|-----------|-----|
| WR19-8-2 | 8" |
| WR19-12-2 | 12" |
| WR19-16-2 | 16" |
| WR19-20-2 | 20" |

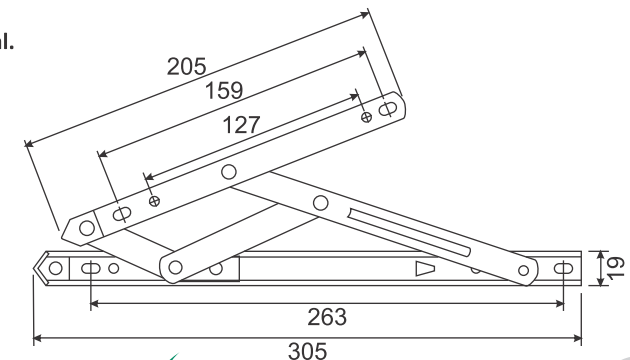

axlent
italy

ACCESORIOS

EVA-2



Cinta doble cara.

- Material: Nylon.
- Espesor: 1/8".
- Ancho: 1/2".
- De: 30 m.

EVA-4



Cinta doble cara.

- Material: Nylon.
- Espesor: 1/4".
- Ancho: 1/2".
- De: 15 m.

WG14



Guantes para vidrio.

- Material: Estambre Palma Latex.
- Venta por par.

Cerradores, sistemas corredizos cerraduras y chapas

XH-073	3
XH-072	3
XH-071	3
KH01	4
KH01-Z	4
KH01Z-S	4
KH01-S	4
KH02	4
KH03	4
B023	4
N0115	4
N0115-C	4
N0208	5
O15-S	5
O2-C	5
O2-S	5
AL03	5
XH-82801	8
XH-82802	8
XH-82803	8
XH-82804	8
XH-82805	8
XH-82806	9

Cerradores, sistemas corredizos cerraduras y chapas

XH-83101	10
XH-83102P	10
XH-83301	10
XH-83302	10
XH-84201	10
XH-84202	11
XH-84201-K	11
XH-84202-K	11
XH-84801	11
XH-84802P	12
J101	13
J102	13

Jaladeras, clips,
bisagras y separadores

K-246-C	14
K-246-S	14
K-247-C	14
K-247-S	14
K-264-C	14
25*300-C	14
25*300-SN	14
19*150-C	15
19*150-SN	15
SH-250-50	15
SH-250-90	15
SH-250-120	15
SH-250-150	15
SH-250-SQ-120	15
SH-250-SQ-150	15
SH-530-20*45	16
SH-270	16
SH260	16
SH-250-K-120	17
SH-250-K-150	17
K120	18
T120	18
K200	18
T200	19
CN200	19

Jaladeras, clips,
bisagras y separadores

K-121-12-C	20
K-121-12-S	20
K-128-12-C	20
K-128-12-S	20
K-239-L	20
K-169-C	20
K-169-S	20
K-170-C	20
K-170-S	20
K-170-1-C	21
K-170-1-S	21
K-826	21
K-827	21
K-163-1	21
K-165	21
K-166	22
K-822	22
K-823	22
K-824	22
K-510-C	22
K-510	22

Jaladeras, clips,
bisagras y separadores

K-512-C	23
K-512	23
K-513	23
K-518-C	23
K-518	23
K-507-C	23
K-507	23
K-508-C	23
K-508	23
K-858-C	24
K-858-S	24
K-861-C	24
K-861-S	24
K-862-C	24
K-862-S	24
K-844	24
K-846	24
K-174-10	25
K-946	25
K-947	25
K-803	25

Jaladeras, clips,
bisagras y separadores

ZL6214-C	25
ZL6214-SN	25
ZL6215-C	26
ZL6215-SN	26
Z6216-C	26
Z6216-SN	26
Z6217-C	26
Z6217-SN	26
Z6218-C	26
Z6218-SN	26
SH310-C	27
SH310-S	27
SH320-C	27
SH320-S	27
SH330-C	28
SH330-S	28
SH340-C	28
SH340-S	28
SH350-C	28
SH350-S	28
SH300-C	29
SH300-S	29
K-258-1	30

Soportes, conectores y complementos

C-005	31
C-003	31
C-004	31
C-001	31
K-957-25	32
K-957-32	32
K-961-25	32
K-961-32	32
M063	33
M063-L	33
M063-R	33
PH800-1-SN	34
PH804-1-SN	34
PH800-SN	34
PH804-SN	34
C011	34
ALC011	35
M112	35
M312	35
M309	35
M109	36
M101	36
M301	36
C012	36
TC012	36
C012-L	37
TC012-L-M10	37
C013	37
C014	37
M126	37
M125H	37

Soportes, conectores y complementos

M125	38
M128	38
M325	38
M075	38
PH001-SN	38
PH002-SN	38
M090	39
PH003-SN	39
PH005-SN	39
K-869-C	39
K-869-S	39
K-870-C	39
K-870-S	39
K-869Z-S	40
K-870Z-S	40
P-871	40
P-872	40
F001	41
F002	41
F004	41
F005	41
F08	41
C101	42
C102	42
C103	42
C104	42
C105	43
M100	44
M100-L	44
M155	45
M156	46
HN06	46

Herrajes para acceso

A-607	47
D-050	47
D-020	48
D-010	48
B-322	49
B200-B	49
D030-B	50
D040	50
ZJ-020	51
HP-L	51

Línea para barra estabilizadora

XH091	52
XH092	52
XH093	52
XH094	52
XH095	53
XH096	53

Línea black

KH01-B	54
KH02-B	54
N0115-B	54
O2-B	54
XH-82801-B	54
XH-82803-B	54
XH-83101-B	55
XH-83102P-B	55
K-247-B	55
25*300-B	55
19*150-B	55
SH-250-50-B	56
SH-250-90-B	56
SH-250-120-B	56
SH-250-150-B	56
SH-530-20*45-B	56
K-169-B	56
K-170-B	56
K-512-B	57
K-518-B	57
K-507-B	57
K-508-B	57
K-869Z-B	57
K-870Z-B	58
SH310-B	58
SH320-B	58
SH330-B	59
SH340-B	59
SH350-B	59

Línea black

SH300-B	60
C-003-B	61
C-004-B	61
PH804-1-B	61
PH804-B	61
C011-B	61
C012-L-B	62
M100-B	62
M155-B	62
D-050-B	63
D-020-B	63
D-010-B	63
CB-322-B	64

Línea Gold

KH01-G	65
N0115-G	65
O2-G	65
K-247-G	65
19*150-G	65
SH-250-50-G	65
SH-530-20*45-G	66
K-512-G	66
K-518-G	66
K-507-G	66
K-508-G	66
SH320-G	67
SH330-G	67
SH-350-G	67

Línea Aluminio

WR01	68
WR02	68
WR09	68
WR03	68
WR04	68
WR05	68
WR20	68
WR06	68
WR10	68
WR12	69
WR7	69
WR8	69
WR11	69
WR13	69
WR15	69
WR16	69
WR17	69
WR23	70
WR24	70
WR25	70
WR26	71
WR27	71
DL001	72
DS01	72
DS02	72
DS03	72
DL002	73
DL003	73
DL004	74
DL005	74

Línea Aluminio

DL006	75
WL001	75
WL002	75
WL003	75
WL004	76
WL006	76
WL008	76
WR14	76
WR14AL	76
HN01	77
HN02	77
HN03	77
HN04	77
HN05	77
HN07	77
HA01	77
WS18-8-2	78
WS18-12-2	78
WS18-16-2	78
WS18-20-2	78
WR19-8-2	78
WR19-12-2	78
WR19-16-2	78
WR19-20-2	78

Accesorios

EVA-2	79
EVA-4	79
WG14	79